



KODEN

OPERATION MANUAL

MARINE RADAR

MDC-2000BB

SERIES

This product is specifically designed to be installed on boats and other means of maritime transport. If your country forms part to the EU, please contact your dealer for advice before attempting to install elsewhere.

Declaration of Conformity



This declaration is issued according to the Directive 2014/53/EU of the European Parliament and of the Council on the harmonization of the laws of the Member States relating to making available on the market of radio equipment.

We, Koden Electronics Co., Ltd.; 5278 Uenohara Uenohara-shi, Yamanashi-Ken ; 409-0112, Japan declare as manufacturer under our sole responsibility that the KODEN Marine Radar

MDC-2000BB Series

intended for use as a Marine Navigation RADAR for use aboard non-SOLAS vessels to which this declaration relates conforms to the following standard(s):

- IEC 60945 ED.4.0 2002; EMC related items
- EN 62368-1:2014/AC:2015/A11:2017
- EN 60950-1:2006+A11:2009+A1:2010+A2:2013+AC:2011+A12:2011
- EN 302 248 V2.1.1:2016-11

Type names: MDC-2003BB (4kW 1.2ft Radome), MDC-2005BB (4kW 2ft Radome), MDC-2004BB (4kW Open Scanner), MDC-2006BB (6kW Open Scanner), MDC-2012BB (12kW Open Scanner)

Consisting of: Processor Unit: MRM-112
Operation Unit: MRO-112
Scanner Unit: RB804(4kW 1.2ft radome) or RB805(4kW 2.0ft radome) or RB806(4kW open scanner) or RB807(6kW open scanner) or RB808(12kW open scanner)
Aerial: RW701A-03(3ft) for RB806 or RW701A-04(4ft) for RB806, RB807, RB808 or RW701A-06(6ft) for RB807, RB808

For assessment, see

EU-type examination (Module B) certificate no: T818650M-01-TEC issued by CTC advanced (0682), Germany

Software: MRM-112 = KM-F87x ; MRO-112 = KM-F89x (x is used as wildcard)

Frequency: 9410MHz \pm 30MHz

Our product is also in compliance to Directive 2011/65/EU of the European Parliament and of the Council of 8 June 2011 on the restriction of the use of certain hazardous substances (RoHS) in electrical and electronic equipment.

EU representative: Koden Elektronik GmbH
Am Gewerbepark 15, D-64823 Gross-Umstadt
Point of contact: Koden Electronics Co.,Ltd.
5278 Uenohara, Uenohara-shi, Yamanashi-Ken, Japan
Mr. JUN HARAYAMA, Manager, Quality Assurance Dept.
Tel.: +81 554 20 5860 Fax: +81 554 20 5875

Date: 26 February, 2020

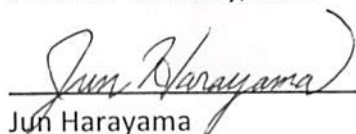
Jun Harayama

Manager, Quality Assurance Dept.

Document No. 79-2731U-X037

- This page intentionally left blank.-

MDC-2000BB Series Operation Manual**Doc No. 0093120012****Document Revision History**

No.	Doc. No / Rev. No.	Revised Date (Y/M/D)	Revised Content
0	0093120012-00	2020/01/10	First edition
1	0093120012-01	2020/02/28	Declaration
2			
3			
4			
5			
6			
7			
8			
9			
10			

Document No. Revised Version Norm

When part of the document needs to be revised, the document has advanced revision number.

The document No. is indicated at the lower right side on the cover and at the left or right side of the footer region of each page.

© 2020 Kodan Electronics Co., Ltd. All rights reserved.

No part of this publication may be reproduced, transmitted, translated in any form by any means without the written permission of Kodan Electronics Co., Ltd. The technical descriptions contained in this publication are subject to change without notice. Kodan assumes no responsibility for any errors, incidentals or consequential damages caused by misinterpretation of the descriptions contained in this publication.

(Note) MDS-2060BB/2010BB including Antenna Scanner unit: RB717A/718A are not complied for CE Approval.





Important Notices

- The re-use and transcription of Operation Manual (hereafter called this manual) needs permission of our company. Our company prohibits the un-authorized re-use and transcription.
- If this manual is lost or damaged, consult our dealer or our company.
- The specification of our products and the content in this manual are subject to changed without notice.
- In the explanation of this manual, the content displayed on the menu of product may be different, depending on the situation. The keys and menus in the illustration may differ in physical font and shape. And some parts may be omitted.
- Our company is not liable for damage and trouble arising from misunderstanding of the content described in this manual.
- Our company is not liable for earthquake, lightning, fire for which our company is not responsible, action by third party, other accident, customer's unintended error/abuse and damage caused by the use under other abnormal condition.
- Our company is not liable for damage of accompaniment (change/loss of memorized content, loss of business profit, stop of business) arising from use or failure of our product.
- If the stored data is changed or lost, irrespective of any cause of trouble and damage, our company is not liable for it.
- Our company is not liable for any damage arising from malfunction caused by combination of such software and connected equipment that did not involve our company.







For Your Safe Operation

Symbol used in this Operation Manual

This manual uses the following symbols. Understand the meaning of each symbol and implement the maintenance and inspection.

Symbol	Meaning
 Warning	Mark for warning This symbol denotes that there is a risk of death or serious injury when not dealing with it correctly.
	Mark for danger high voltage This symbol denotes that there is a risk of death or serious injury caused by electric shock when not dealing with it correctly.
 Caution	Mark for caution This symbol denotes that there is a risk of slight injury or damage of device when not dealing with it correctly.
	Mark for prohibition This symbol denotes prohibition of the specified conduct. Description of the prohibition is displayed near the mark.
IMPORTANT	Mark for important matters This mark denotes that there is a possibility that data loss may interfere the operation or that the expected result may not be obtained when the radar is not dealt correctly.
	Mark for reference This mark shows the part to be referred to concerning this description.

Caution Item on Equipment

	<p>Caution on a high voltage inside. A high voltage, which may risk your life, is used. This high voltage remains in the circuit after you have powered off switch. To prevent touching the high voltage circuit inadvertently, the protective cover is provided to the high voltage circuit and the high voltage caution label is affixed. Ensure to power off switch for your safety and discharge the electricity remaining in the capacitor before starting to check. An engineer authorized by our company should inspect and maintain the circuit.</p>
 <p>Warning</p>	<p>Ensure to switch off the power in the boat. If the power switch is inadvertently powered on during work, you will be electrified. To prevent such accident from occurring, ensure to switch off the power in the boat and the power of equipment. Furthermore, it is safer to hang the caution tag with description of [Under Work] near the power switch of equipment.</p>
 <p>Warning</p>	<p>Caution on dust Inhaling dust may cause A respiratory disease. When cleaning the inside of equipment, be careful not to inhale dust. Wearing a safety mask is recommended.</p>
 <p>Caution</p>	<p>Caution on location of equipment Do not install the equipment where it is excessively damp and suffers from excessive water drops.</p>
 <p>Caution</p>	<p>Caution on static electricity The static electricity may be generated from the carpet on the floor in the cabin or clothes made of synthetic fiber. The static electricity may destroy the electronic parts on the circuit board. Handle the circuit board, taking the suitable anti-static measures.</p>
	<p>Prohibited matter Any Display and Scanner unit combination other than specified in the manual is prohibited and will void manufacturer's warranty.</p>

Caution Item on Handling

 <p>Caution</p>	<p>Caution on the rotating aerial</p> <p>The radar antenna may start to rotate without notice. Please stand clear from the antenna for your safety.</p>
---	--

ENGLISH

 <p>Caution</p>	<p>Caution on electromagnetic disturbance</p> <p>The operating Antenna & Scanner unit radiates high-energy electromagnetic wave. It may cause harmful effect for human body due to its continuous irradiation. As International regulation says, electromagnetic waves less than 100 watt/m² does not have a harmful effect on human bodies, but some kind of medical devices such as heart pacemakers are sensitive even under the low energy electromagnetic wave. Any personnel with such a device should keep away from the electromagnetic wave generating position at all times.</p> <p>Specified power density and distance from the radar (in accordance with the provision as specified in IEC 60945)</p> <table border="1" style="width: 100%; border-collapse: collapse;"> <thead> <tr> <th style="width: 20%;">Model</th> <th style="width: 30%;">Xmit power/Antenna length</th> <th style="width: 15%;">100W/m²</th> <th style="width: 15%;">10W/m²</th> </tr> </thead> <tbody> <tr> <td>MDC-2003BB</td> <td>4kW / 1.2 feet (Radome antenna)</td> <td>0.6m</td> <td>1.95m</td> </tr> <tr> <td>MDC-2005BB</td> <td>4kW / 2 feet (Radome antenna)</td> <td>0.8m</td> <td>2.54m</td> </tr> <tr> <td rowspan="2">MDC-2004BB</td> <td>4kW / 3 feet (Open antenna)</td> <td>0.9m</td> <td>2.85m</td> </tr> <tr> <td>4kW / 4 feet (Open antenna)</td> <td>1.01m</td> <td>3.2m</td> </tr> <tr> <td>MDC-2006BB</td> <td>6kW / 4feet (Open antenna)</td> <td>1.09m</td> <td>3.46m</td> </tr> <tr> <td>MDC-2060BB</td> <td>6kW / 6 feet (Open antenna)</td> <td>1.30m</td> <td>4.10m</td> </tr> <tr> <td>MDC-2012BB</td> <td>12kW / 4feet (Open antenna)</td> <td>1.55m</td> <td>4.89m</td> </tr> <tr> <td>MDC-2010BB</td> <td>12kW / 6 feet (Open antenna)</td> <td>1.84m</td> <td>5.81m</td> </tr> </tbody> </table>	Model	Xmit power/Antenna length	100W/m ²	10W/m ²	MDC-2003BB	4kW / 1.2 feet (Radome antenna)	0.6m	1.95m	MDC-2005BB	4kW / 2 feet (Radome antenna)	0.8m	2.54m	MDC-2004BB	4kW / 3 feet (Open antenna)	0.9m	2.85m	4kW / 4 feet (Open antenna)	1.01m	3.2m	MDC-2006BB	6kW / 4feet (Open antenna)	1.09m	3.46m	MDC-2060BB	6kW / 6 feet (Open antenna)	1.30m	4.10m	MDC-2012BB	12kW / 4feet (Open antenna)	1.55m	4.89m	MDC-2010BB	12kW / 6 feet (Open antenna)	1.84m	5.81m
Model	Xmit power/Antenna length	100W/m ²	10W/m ²																																	
MDC-2003BB	4kW / 1.2 feet (Radome antenna)	0.6m	1.95m																																	
MDC-2005BB	4kW / 2 feet (Radome antenna)	0.8m	2.54m																																	
MDC-2004BB	4kW / 3 feet (Open antenna)	0.9m	2.85m																																	
	4kW / 4 feet (Open antenna)	1.01m	3.2m																																	
MDC-2006BB	6kW / 4feet (Open antenna)	1.09m	3.46m																																	
MDC-2060BB	6kW / 6 feet (Open antenna)	1.30m	4.10m																																	
MDC-2012BB	12kW / 4feet (Open antenna)	1.55m	4.89m																																	
MDC-2010BB	12kW / 6 feet (Open antenna)	1.84m	5.81m																																	

FRENCH



Caution

Mise en garde relative aux perturbations électromagnétiques produites par les radars de navire

L'antenne & l'émetteur des radars de navire ont un rayonnement d'ondes électromagnétique de haute intensité. Ceci peut causer des effets nocifs pour le corps humain en raison de son rayonnement continu. Comme la réglementation internationale le spécifie, les ondes électromagnétiques à moins de 100 watt/m² n'ont pas un effet néfaste sur le corps humain, mais certains types d'appareils médicaux tels que les stimulateurs cardiaques peuvent être affectés même par des ondes électromagnétiques de faible énergie. Tout membre du personnel avec un tel dispositif devrait se tenir à l'écart des générateurs d'ondes électromagnétiques en tout temps.

Spécification de densité de la puissance et de la distance du radar (conformément à la disposition comme spécifié dans la IEC 60945)

Nom Modèle	Puissance de transmission / longueur d'antenne	100W/m ²	10W/m ²
MDC-2003BB	4kW / Antenne 1.2 pieds	0.6m	1.95m
MDC-2005BB	4kW / Antenne 2 pieds	0.8m	2.54m
MDC-2004BB	4kW / Antenne 3 pieds	0.9m	2.85m
	4kW / Antenne 4 pieds	1.01m	3.2m
MDC-2006BB	6kW / Antenne 4 pieds	1.09m	3.46m
MDC-2060BB	6kW / Antenne 6 pieds	1.30m	4.10m
MDC-2012BB	12kW / Antenne 4 pieds	1.55m	4.89m
MDC-2010BB	12kW / Antenne 6 pieds	1.84m	5.81m

Warning Statements related to FCC and IC rules

- IC RSS-GEN, Sec 8.3 Warning Statement- (Required for Transmitters w/ detachable antennas)

ENGLISH:

This radio transmitter (identify the device by certification number, or model number if Category II) has been approved by Industry Canada to operate with the antenna types listed below with the maximum permissible gain and required antenna impedance for each antenna type indicated. Antenna types not included in this list, having a gain greater than the maximum gain indicated for that type, are strictly prohibited for use with this device.

FRENCH:

Le présent émetteur radio (identifier le dispositif par son numéro de certification ou son numéro de modèle s'il fait partie du matériel de catégorie I) a été approuvé par Industrie Canada pour fonctionner avec les types d'antenne énumérés ci-dessous et ayant un gain admissible maximal et l'impédance requise pour chaque type d'antenne. Les types d'antenne non inclus dans cette liste, ou dont le gain est supérieur au gain maximal indiqué, sont strictement interdits pour l'exploitation de l'émetteur.

Antenna type name	Antenna Gain (dBi)	Required Impedance (ohm)
(440mm RADOME)	22.0dBi	50ohm
(640mm RADOME)	24.0dBi	50ohm
RW701A-03	25.3dBi	50ohm
RW701A-04	27.0dBi	50ohm
RW701A-06	28.5dBi	50ohm

- IC RSS-102, Sec 2.6 Warning Statement Requirements

ENGLISH:

The applicant is responsible for providing proper instructions to the user of the radio device, and any usage restrictions, including limits of exposure durations. The user manual shall provide installation and operation instructions, as well as any special usage conditions, to ensure compliance with SAR and/or RF field strength limits. For instance, compliance distance shall be clearly stated in the user manual.

FRENCH:

Le demandeur est responsable de fournir des instructions appropriées et toute restriction d'utilisation, y compris les limites des durées d'exposition, à l'utilisateur de l'appareil radio. Le manuel de l'utilisateur doit fournir des instructions d'installation et d'utilisation, ainsi que toutes les conditions d'utilisation spéciales, pour assurer la conformité aux limites SAR et / ou RF. Par exemple, la distance de conformité doit être clairement indiquée dans le manuel de l'utilisateur.

- IC RSS-GEN, Sec 8.4 Warning Statement- (Required for license-exempt devices)

ENGLISH:

This device complies with Industry Canada license-exempt RSS standard(s). Operation is subject to the following two conditions: (1) this device may not cause interference, and (2) this device must accept any interference, including interference that may cause undesired operation of the device.

FRENCH:

Le présent appareil est conforme aux CNR d'Industrie Canada applicables aux appareils radio exempts de licence. L'exploitation est autorisée aux deux conditions suivantes : (1) l'appareil ne doit pas produire de brouillage, et (2) l'utilisateur de l'appareil doit accepter tout brouillage radioélectrique subi, même si le brouillage est susceptible d'en compromettre le fonctionnement.

- Warning statement regarding RF exposure compliance

ENGLISH:

The user manual of devices intended for controlled use shall also include information relating to the operating characteristics of the device; the operating instructions to ensure compliance with SAR and/or RF field strength limits; information on the installation and operation of accessories to ensure compliance with SAR and/or RF field strength limits; and contact information where the user can obtain Canadian information on RF exposure and compliance. Other related information may also be included.

FRENCH:

Le manuel de l'utilisateur des dispositifs destinés à une utilisation contrôlée doit également comporter des informations relatives aux caractéristiques de fonctionnement du dispositif; Le mode d'emploi pour assurer la conformité aux limites SAR et / ou RF; Des informations sur l'installation et le fonctionnement des accessoires afin d'assurer la conformité aux limites SAR et / ou RF; Et des coordonnées où l'utilisateur peut obtenir des renseignements canadiens sur l'exposition aux radiofréquences et la conformité. D'autres renseignements connexes peuvent également être inclus.

- FCC Part 15.19 Warning Statement

THIS DEVICE COMPLIES WITH PART 15 OF THE FCC RULES. OPERATION IS SUBJECT TO THE FOLLOWING TWO CONDITIONS: (1) THIS DEVICE MAY NOT CAUSE HARMFUL INTERFERENCE, AND (2) THIS DEVICE MUST ACCEPT ANY INTERFERENCE RECEIVED, INCLUDING INTERFERENCE THAT MAY CAUSE UNDESIRE OPERATION.

- FCC Part 15.21 Warning Statement





NOTE: THE GRANTEE IS NOT RESPONSIBLE FOR ANY CHANGES OR MODIFICATIONS NOT EXPRESSLY APPROVED BY THE PARTY RESPONSIBLE FOR COMPLIANCE. SUCH MODIFICATIONS COULD VOID THE USER'S AUTHORITY TO OPERATE THE EQUIPMENT.

- FCC Part 15.105(b) Warning Statement



NOTE: This equipment has been tested and found to comply with the limits for a Class B digital device, pursuant to part 15 of the FCC Rules. These limits are designed to provide reasonable protection against harmful interference in a residential installation. This equipment generates uses and can radiate radio frequency energy and, if not installed and used in accordance with the instructions, may cause harmful interference to radio communications. However, there is no guarantee that interference

will not occur in a particular installation. If this equipment does cause harmful interference to radio or television reception, which can be determined by turning the equipment off and on, the user is encouraged to try to correct the interference by one or more of the following measures:

- Reorient or relocate the receiving antenna.
- Increase the separation between the equipment and receiver.
- Connect the equipment into an outlet on a circuit different from that to which the receiver is connected.
- Consult the dealer or an experienced radio/TV technician for help.

 Warning	Do not disassemble or modify. It may lead to trouble, fire, smoking or electric shock. In case of trouble, contact our dealer or our company.
 Warning	In case of smoke or fire, switch off the power in the boat and the power of equipment. It may cause fire, electric shock or damage.
	<p>Caution on the remaining high voltage.</p> <p>A high voltage may remain in the capacitor for several minutes after you have powered off. Before inspecting inside, wait at least 5 minutes after powering off or discharging the remaining electricity in an appropriate manner. Then, start the work.</p>
 Caution	The information displayed in this unit is not provided directly for your navigation. For your navigation, be sure to see the specified material.
 Caution	Use the specified fuse. If un-specified fuse is used, it may cause a fire, smoke or damage.

Caution on Display unit

 Caution	Do not push or scrub the surface of the Display unit with a pointed tip of a hard matter (tool, tip of a pen, etc) Scars could be made.
 Caution	Do not press the surface of the Display unit. Interference stripes or display abnormality could occur.

Disposal of this radar

This radar shall be disposed according to the municipal regulations or rules.

Break in procedure of stored radar**Caution**

Following procedure is recommended for “Break In” of the stored radar.

Otherwise the radar sometimes exhibits unstable transmitting operation such as arcing at its initial operation after long period of storage and make the operation more difficult.

1. Extend preheat time as long as possible (preferably 20 to 30 minutes).
2. Set the pulse length to the shortest one and start the operation. When the operation in the shortest pulse is stable then go to operation in longer pulse and repeat the similar step until the operation reaches to the final pulse condition.

Contents

Document Revision History.....	i	1.12 EBL	1-10
Important Notices	ii	1.13 VRM	1-10
For Your Safe Operation	iii	1.14 Use of Function keys	1-11
Break in procedure of stored radar	xii	How to use [F1] - [F6] keys	1-11
Contents	xiii	1.15 Use of Cursor.....	1-11
Introduction	xvi	1.16 Measuring the distance and	
System Configuration.....	xvii	bearing between two points	1-12
Configuration of Equipment.....	xviii	How to operation.....	1-12
Chapter 1 Basic Operation.....	1-1	1.17 Camera Display	1-12
1.1 How to read the radar screen	1-3	How to connect the CCD	
1.2 How to use the keys.....	1-4	camera	1-12
1.3 Power On/Off	1-6	How to display the video of the	
Power On	1-6	CCD camera	1-12
Power Off	1-6	Chapter 2 How to use the menu.....	2-1
Language Selection at Initial		2.1 How to operate the menu	2-1
Start-up	1-6	Display/Non-display of Menu	2-1
1.4 Brilliance Adjustment.....	1-6	Operation of Menu	2-1
Brightness Adjustment of Display		2.2 Setting of Display Mode	2-1
.....	1-6	H UP (Head Up).....	2-2
Brightness Adjustment of		N UP (North Up).....	2-2
Panel.....	1-6	C UP (Course Up).....	2-2
1.5 Transmission.....	1-6	WPT UP (Waypoint Up)	2-3
Start of Transmission	1-6	Relative Motion (RM) and True	
Stop of Transmission	1-6	Motion (TM).....	2-3
1.6 Switch-over of Range	1-7	True Motion Reset	2-4
Change of Range.....	1-7	2.3 Display Select	2-4
Change of Sub-screen Range ...	1-7	PPI Display	2-4
1.7 Gain Adjustment.....	1-7	PPI/PPI Display.....	2-4
Adjustment of Main-dscreen Gain	1-7	Note on PPI/PPI Display.....	2-5
Adjustment of Sub-screen Gain.	1-7	PPI/NAV Display	2-5
1.8 STC Adjustment.....	1-8	Note on PPI/NAV Display.....	2-5
STC Adjustment.....	1-8	2.4 Setting of Signal Process.....	2-5
1.9 FTC Adjustment	1-9	2.5 Setting of Pulse Width.....	2-5
1.10 Setting of OFF CENTER.....	1-10	2.6 Trailing	2-5
1.11 Setting of Enhance		Relative Display (R)	2-5
(Enlarged Target)	1-10	True Display (T)	2-6

2.7	Display Color	2-6		Temperature Unit.....	3-1
2.8	Cursor Shape	2-7		Depth Unit	3-1
2.9	PI (Parallel Index Line).....	2-7		Position Display.....	3-1
2.10	Bearing Mode.....	2-7		WPT Display.....	3-2
2.11	Vector	2-7		Rotation Speed.....	3-2
2.12	Alarm	2-8		ALL PPI	3-2
	IN Mode.....	2-8		Guide.....	3-2
	OUT Mode.....	2-8		Buzzer	3-2
	Setting of Alarm Range	2-8		Motor Speed.....	3-2
2.13	Sleep	2-8		N UP/S UP	3-2
	Operation during executing the			Cursor Display.....	3-2
	sleep.....	2-8		Radar Setting Display	3-2
2.14	AIS.....	2-9		Menu Operation	3-2
	Setting of Symbol Display of				
	AIS.....	2-9	3.3	Setting of Adjustment Items	3-2
	Setting of Detailed Information of			Bearing Setting.....	3-3
	Designated Symbol Display	2-9		TX Delay Adjustment.....	3-3
	Types and Meanings of AIS			MBS.....	3-3
	Symbols.....	2-9		STC Curve	3-4
2.15	ATA.....	2-10		Tune Select	3-5
	Automatic Acquisition	2-10		Automatic Tuning	3-5
	Manual Acquisition	2-10		Manual Tune Adjustment.....	3-5
	Target Level.....	2-11		Pulse Width	3-5
	Target Delete	2-11		Interference Rejection	3-6
	Number of Acquisition	2-11		Echo Color Divide	3-6
	Information Display	2-11	3.4	Signal Select	3-6
	ATA Performance	2-11		NMEA.....	3-6
	Types and Meanings of ATA			Connection with the KODEN GPS	
	Symbols.....	2-12		compass	3-7
Chapter 3	How to use the system		3.5	Preset.....	3-7
	menu	3-1		Nav Display select.....	3-7
3.1	Display of System Menu	3-1		Language Select	3-7
	Display the System menu	3-1		[F1]-[F6] Key Set.....	3-7
	Return to the normal menu	3-1		Select Range S/M/L	3-7
3.2	Setting of Assist Items.....	3-1		Echo Color Set.....	3-7
	Range Rings	3-1		Trail Color Set	3-7
	Range Unit	3-1		Display Color Set	3-7
	Speed Unit.....	3-1		Camera Position Correction.....	3-7
			3.6	Maintenance.....	3-7
				Processor Unit.....	3-7

Antenna.....	3-7	unit	5-29
Panel Test	3-7	Pin Assignment of Rear	
LCD Test	3-8	Connector	5-30
Operation Hours Reset	3-8	Connection of DC power	
TX Hours Reset	3-8	cable	5-31
ALL Reset	3-8	Grounding	5-31
System Program Renewal	3-8	Connection with the AIS	
Chapter 4 Maintenance	4-1	Receiver	5-31
4.1 Maintenance	4-1	Connection with the navigation	
4.1.1 Monthly Inspection	4-1	equipment	5-31
4.1.2 Yearly Inspection.....	4-2	Connection of CCD Camera	5-32
4.2 Fuse Replacement.....	4-3	5.7 List of Input/Output Sentence ..	5-32
4.3 Consumables	4-3	Input Sentence.....	5-32
4.4 Trouble Diagnosis	4-3	Output Sentence	5-33
4.4.1 Information required for		Chapter 6 Attached Table	6-1
requesting a repair	4-3	6.1 Menu Configuration.....	6-1
4.4.2 Error Display	4-3	6.2 Specifications	6-4
4.4.3 Self-diagnostic Function	4-4	6.3 External View	6-6
4.4.4 Inspection at Each Location.....	4-5	Chapter 7 Principle of radar system	7-1
Chapter 5 Equipment.....	5-1	7.1 What is the radar system?	7-1
5.1 Antenna Installation	5-1	Side lobe	7-1
Determining the location of		Beam width	7-1
the installation	5-1	7.2 Characteristics of radar radio	
How to shift the antenna from an		wave.....	7-2
obstacle.....	5-2	Target with less reflection	7-2
Installation of Antenna.....	5-3	Radar shadow.....	7-2
Installation of Radome Antenna.	5-3	False image	7-2
Setting of Open Antenna.....	5-4	7.3 Radar interference	7-4
Installation of Antenna.....	5-5		
Cable Connection	5-7		
5.2 Mutual Connection Diagram	5-22		
5.3 Processor Unit Installation	5-24		
5.4 Operation Unit Installation.....	5-25		
5.4.1 Desk-top Installation	5-25		
5.4.2 Flush-mount Installation.....	5-26		
5.5 Adjustment after Installation.....	5-28		
5.6 Wiring.....	5-29		
Cable connection to the Processor			

Introduction

Thank for your purchase of KODEN marine radar MDC-2000BB Series.

The quality and endurance of a unit is well considered. For the best performance, read this Operation Manual and operate a unit correctly and safely.

The main features of this unit are as follows.

- The high performance radar is Black Box type and can be used for professional use.
- In the true trail function, as moving targets such as other ships are displayed being tailed and stationary targets such as land are displayed being fixed, the moving targets and fixed targets can be easily discriminated.
- Two screen images of different ranges can be displayed. If you set a near distance screen and a far distance, you can navigate properly and grasp a situation.
- The automatic tracking function (ATA) is provided. The maximum 50 targets can be tracked. The current motion of other ships can be grasped in a vector and numeral so that it helps your ship to navigate safely. (Optional)
- By connecting the AIS receiver, the gathered information such as name, heading and speed of a ship can be displayed. (Optional interface)
- The processor unit can connect to any VGA type display. (VGA type display : Prepared by a customer)
- A video from a CCD camera can be displayed. The inside of a ship can be observed by a camera installed at the engine room helps your ship navigate safely. (CCD camera: Prepared by a customer)
(CCD camera cable: Optional)
- With the adoption of the GAIN/STC rotary knob, the operability is enhanced.





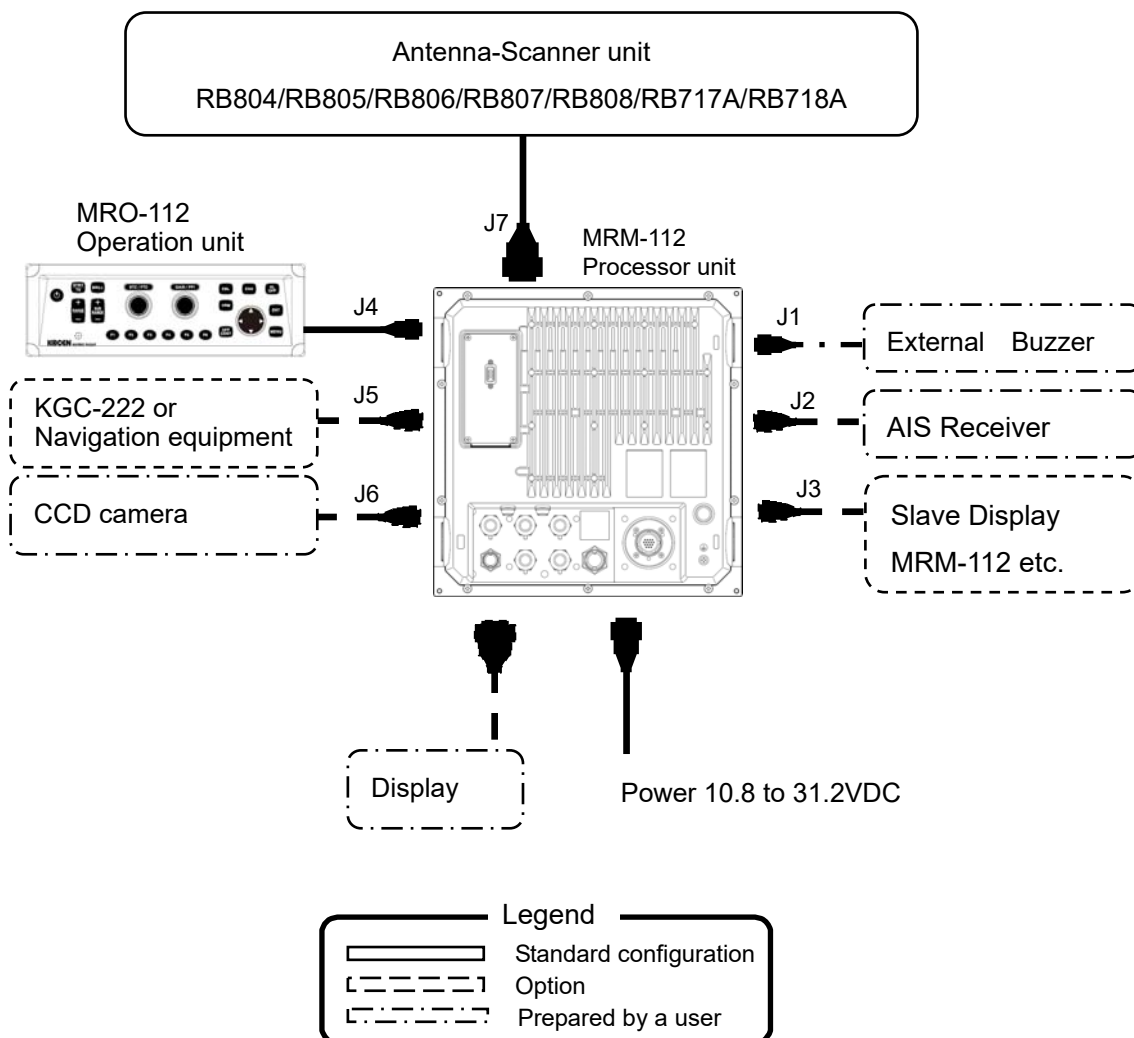

System Configuration

Connection Diagram

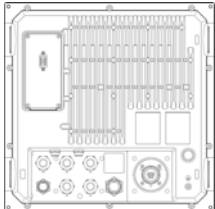

Configuration of Equipment

Standard Equipment Configuration List

No	Name of item	Type	Remarks	Weight/ Length	Quantity
1	Processor unit 	MRM-112		5.1 kg	1
2	Operation unit 	MRO-112	With connecting cable (CW-601-5M)	0.94 kg	1
3	DC power cable 	CW-259-2M	3-pin water resistant connector and one end plain	2 m	1
4	Fuse 	F-1065-15A Cylinder (ø 6.4x30)	Normal fusion type for main power		1
5	Fuse 	MF51NN250V5A Cylinder (ø 5.2x20)	Normal fusion type for motor power		1
6	Fuse 	F-7142-0.3A Cylinder (ø5.2x20)	Normal fusion type for high voltage power		1
7	Connector 	BD-06BFFA-LL6001	6-pin water resistant connector		1
8	Operation Manual	MDC-2000BB.SER.OM.E	English		1
9	Quick Reference	MDC-2000BB.SER.QR.E	English		1

Types of Antenna-scanner unit

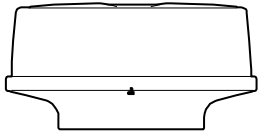
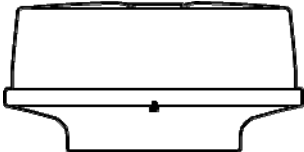
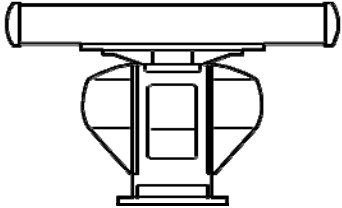
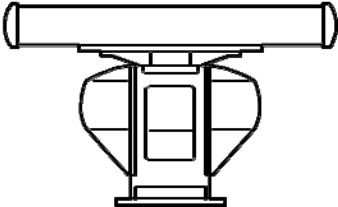
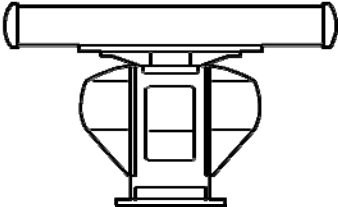
No.	Type	Transmitting Power	Shape	Remarks	Weight/Length
1	RB804 	4kW	Radome	Interconnecting cable, 10m*, 242J158055A-10M	8.3kg / 1.2ft
2	RB805 	4kW	Radome	Interconnecting cable, 10m*, 242J158055A-10M	10kg / 2ft
3	RB806 with RW701A-03/04 	4kW	Open	Interconnecting cable, 10m*, 242J159098A-10M	21kg / 3ft
					22kg / 4ft
4	RB807 with RW701A-04/06 	6kW	Open	Interconnecting cable, 15m**, CW-845-15M	24kg / 4ft
					26kg / 6ft
5	RB808 with RW701A-04/06 	12kW	Open	Interconnecting cable, 15m**, CW-845-15M	24kg / 4ft
					26kg / 6ft

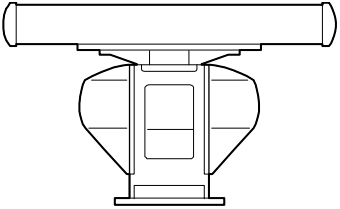
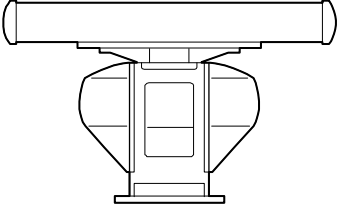
No.	Type	Transmitting Power	Shape	Remarks	Weight/Length
6	RB717A with RW701A-04/06 	6kW	Open	Interconnecting cable, 15m*, 242J159098B-15M	23kg / 4ft
					25kg / 6ft
7	RB718A with RW701A-04/06 	12kW	Open	Interconnecting cable, 15m*, 242J159098B-15M	23kg / 4ft
					25kg / 6ft

* Cables of 15m, 20m and 30m are available. (Optional)

** Cables of 20m, 30m, 40m, 50m, 65m and 100m are available. (Optional)

Optional List

No.	Item Name	Type	Remarks	Cable Length
1	GPS compass	KGC-222	GPS/Heading measuring	
2	AIS interface board	AIS-110	100 targets	
3	Cable for AIS receiver	CW-387-5M	8-pin water resistant connector and one end plain	5m
4	ATA board	MRE-340		
5	Cable for slave display	CW-561-10M	12-pin water resistant connectors at both ends	10m
6	Power rectifier	PS-010	With 2 pieces of 5A fuse	
7	AC power cable	VV-2D8-3M	Both ends plain	3m
8	Cable for navigation cable	CW-373-5M	6-pin water resistant connectors at both ends	5m
		CW-376-5M	6-pin water resistant connector and one end plain	5m
9	CCD Camera cable	CW-405-0.3M	7-pin water resistant connector and RCA connector (female)	0.3m
10	Connector for External Buzzer	BB-02BFFA-LL7001	2-pin water resistant connector	

- This page intentionally left blank.-

Chapter 1 Basic Operation

The basic operation of this unit is as follows. For detailed explanation, refer to each item in this manual.

1. Press the [] to turn on the power.

 1.3 Power On/Off

2. When [ST'BY] appears, press the [STBY/TX] key to start the transmission.

 1.5 Transmission

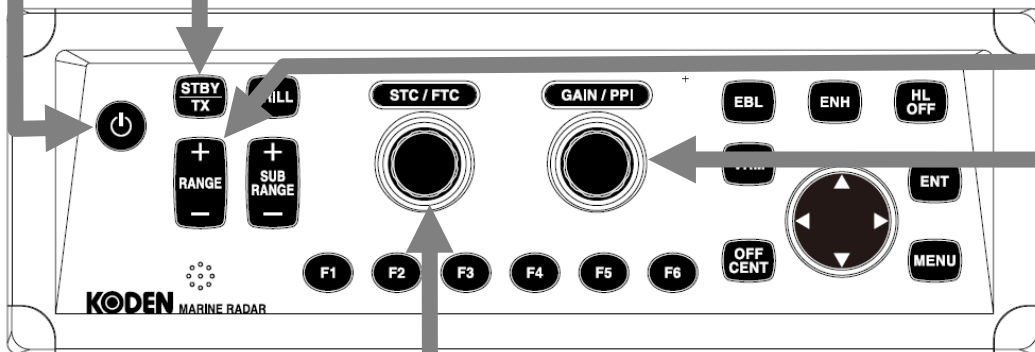

5. Rotate the [STC/FTC] knob to adjust the sea surface reflection suppression effect when the S bar value changes. The suppression effect becomes strong when rotating clockwise the knob and becomes weak when rotating counterclockwise the knob.

- This function reduces the gain at a near distance. If you turn clockwise the knob too much, desired objects may disappear. Adjust properly to meet the weather condition.

Example of STC adjustment :

× : The suppression is too weak.

The reflection from sea surface is displayed.

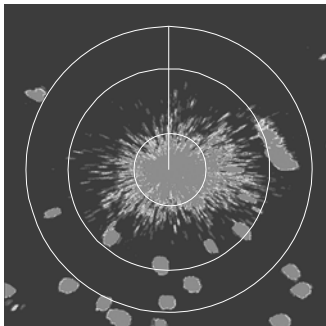

○ : Optimum suppression.

The desired objects are displayed.

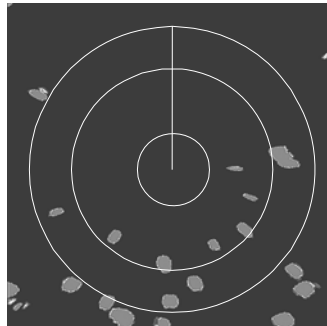

× : The suppression is too strong.

Some objects are not displayed.

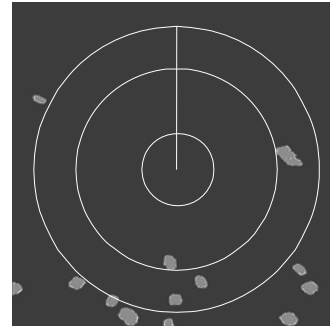

 1.8 STC adjustment

3. Change the observation range with the [- RANGE +] key.

When pressing the [+] key, the observation range expands.
 When pressing the [-] key, the enlarged surrounding around own ship can be observed.
 To make it easier to observe the range you desire, change the range.

Example of display :

Long range : Far distance

Middle range : Middle distance

Short range : Near distance

Objects at far distance
 can be covered.

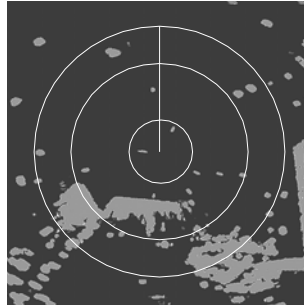
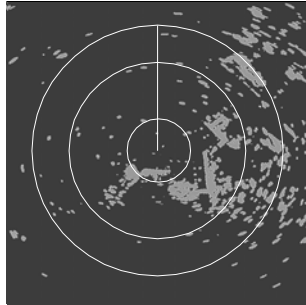

Objects near own ship
 can be easily confirmed.

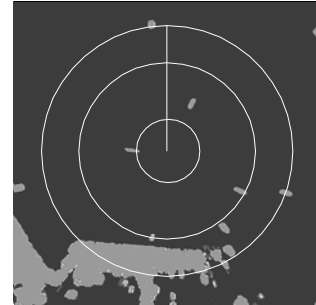

1.6 Switch-over of range

4. Adjust the gain by rotating the [GAIN] knob.

The gain becomes high when rotating clockwise the knob and becomes low when rotating counterclockwise the knob.

- When the observation range is narrow or targets are crowded, reduce the gain so that targets can be easily seen.
- When the observation range is wide, if the gain is increased, it is effective. But, due to noise increase, small targets become hard to be seen.

Example of gain adjustment:

× : Too high gain
 Noise is also displayed.

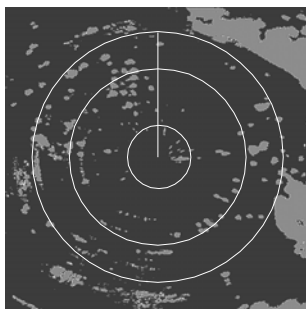

○ : Optimum gain
 Desired targets are displayed.



× : Too low gain
 Some targets are not displayed.

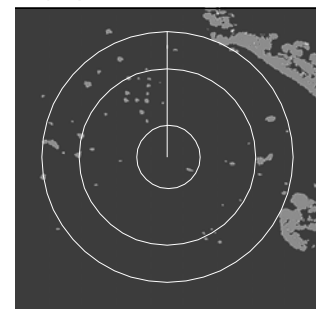

1.7 Gain adjustment

1.1 How to read the radar screen

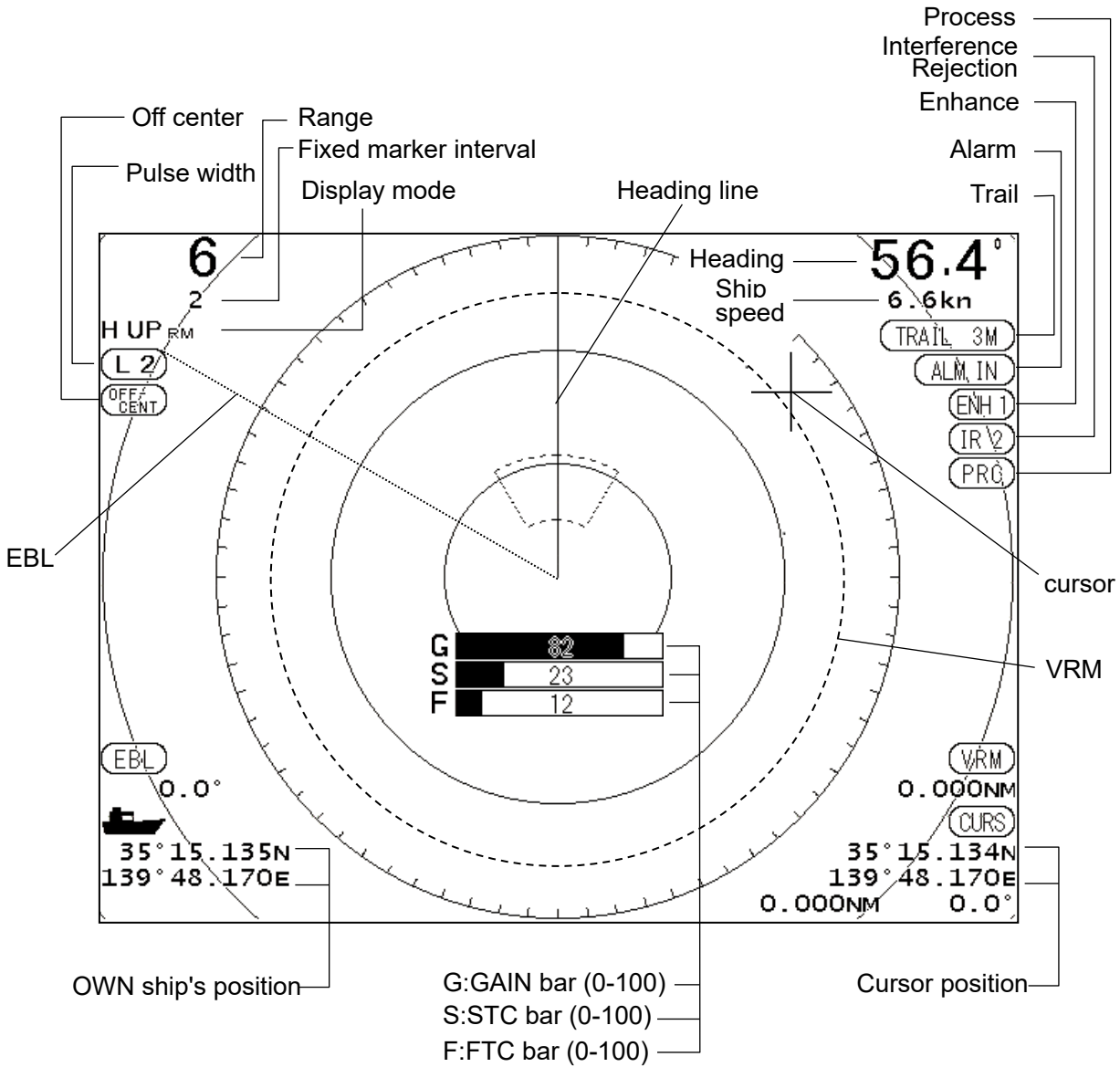

1.2 How to use the keys

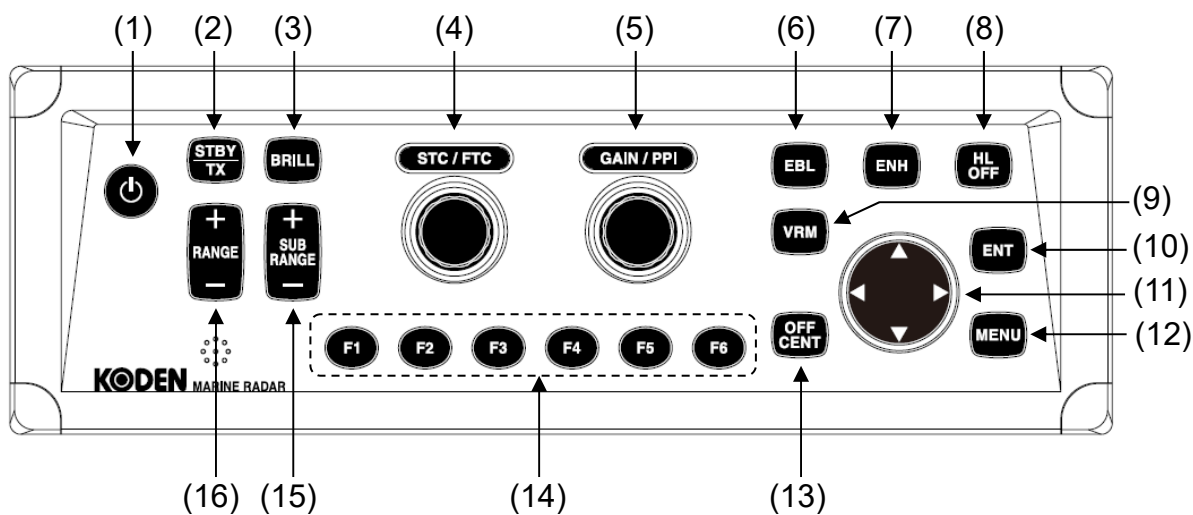

Various adjustment items can be set by operating each key.

The menu is displayed by pressing the [MENU] key, and closes when pressing the [MENU] key again.

Number	Key name	Explanation
(1)	[⏻]	Push: Turns on the power. Continuously pressing: Turns on or off the power.
(2)	[STBY/TX]	Starts or stops the transmission.
(3)	[BRILL]	Adjusts the brilliance and the brightness of the panel.
(4)	[STC/FTC]	Rotate: Changes the STC or FTC. Push: STC and FTC change alternately.
(5)	[GAIN/PPI]	Rotate: Changes the gain. Push: Changes the gain adjustment of sub-screen (right screen of PPI/PPI).
(6)	[EBL]	The On/Off display of EBL is toggled by pressing the [EBL] key. Operate the EBL during display with the [◀] and [▶] keys.
(7)	[ENH]	Setup of ENHANCE changes.
(8)	[HL OFF]	Hide heading line while [HL OFF] key is pressed.
(9)	[VRM]	The On/Off display of VRM is toggled by pressing the [VRM] key. Operate the VRM during display with the [▲] and [▼] keys.
(10)	[ENT]	Press: measures bearing of distance between two points. The value in the menu is set. (Some of functions) Continuously pressing: The cursor moves to the own ship's position.
(11)	CURSOR [▲], [▼] [◀], [▶]	Selects the menu item. Changes the content of set value. Moves the cursor.
(12)	[MENU]	Opens or closes the menu.
(13)	[OFF CENT]	After pressing the [OFF CENT] key, if [▲] or [▼] key is pressed, the ON/OFF setup of the OFF CENTER changes. After pressing the [▶] key with ON selected and moving the cursor, if the [ENT] key is pressed, the position of cursor is set as a position of own ship.
(14)	[F1] to [F6]	Recall directly the preset menu item.
(15)	[- SUBRANGE +]	Changes the range setup of sub-screen (right screen of PPI/PPI).
(16)	[- RANGE +]	Changes the range setup.

When the alarm is functioning, the alarm stops by operating any key.

1.3 Power On/Off

Power On

- 1 Press the [] key to turn on the power. The start-up menu is displayed. During the display of start-up menu, the memory is automatically checked. If the check result is correct, the radar image appears, and start count down time for magnetron preheat.

Power Off

- 1 When turning off the power, keep pressing the [] key until display [Turns off power].

Caution



Re-entry of power shall be performed after having passed for longer than 3 seconds after power-off.

Language Selection at Initial Start-up

When turning on the power for the first time after [ALL RESET], the [LANGUAGE] menu appears.



- 1 Select the language with [▲] and [▼] keys. During display of [LANGUAGE] menu, pressing the [◀] key will return to the initial setup menu. Pressing the [▶] key will redisplay the [LANGUAGE] menu.



- 2 Press the [MENU] key to set the language.

1.4 Brilliance Adjustment

Brightness Adjustment of Display

The brilliance of menu can be adjusted to make it easier to see.

Setup: (1 to 10) (Initial value: 10)

- 1 Press the [BRILL] key.
- 2 Press the [▲] and [▼] keys. "1" is the darkest. "10" is the brightest.

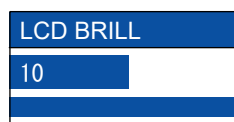

- 3 Press the [MENU] key or [ENT] key to close the menu.

Brightness Adjustment of Panel

The panel brightness can be adjusted,

Setup: (1 to 10) (Initial value: 5)

- 1 Press the [BRILL] key. When [LCD BRILL] appears, press the [BRILL] key again.
- 2 Select the level with the [▲] and [▼] keys. "1" is the darkest. "10" is the brightest.



- 3 Press the [MENU] key or [ENT] key to close the menu.

1.5 Transmission

Start of Transmission

After turning on the power, remaining time of pre-heat is displayed in the center of the screen. After 120 seconds, ST'BY appears in the center of the screen and the unit becomes "STBY" state. On the "STBY" state, when the [STBY/TX] key is pressed, the unit starts the transmission.

Stop of Transmission

On the "TX" state, when the [STBY/TX] key is pressed, the unit stops the transmission and returns to the "STBY" mode.

1.6 Switch-over of Range

The observation range can be changed.

Change of Range

- 1 Press the [- RANGE +] key.
When pressing the [+] key, an image shrinks but the observation range expands.
When pressing the [-] key, the observation range becomes narrow but the enlarged surroundings around own ship can be seen.

The value of the range is displayed at the upper left side of the screen.

Change of Sub-screen Range

Change the range of the right screen (sub-screen) of the PPI/PPI menu.

 For the PPI/PPI screen, refer to 2.4 Display Select.

- 1 Press the [- SUB RANGE +] key.
When pressing the [+] key, an image shrinks but the observation range expands.
When pressing the [-] key, the observation range becomes narrow but the enlarged surroundings around own ship can be seen.

The value of the range is displayed at the upper left side of the screen.

1.7 Gain Adjustment

Adjust the gain according to the distance range and reflection from the sea surface/rain/snow to observe an image easily.

When the [GAIN/PPI] knob is rotated, the GAIN bar is displayed. The number in the GAIN bar varies between 0 and 100.

Adjustment of Main-screen Gain

- 1 When rotating clockwise the [GAIN/PPI] knob, the gain increases.
When rotating counterclockwise the [GAIN/PPI] knob, the gain decreases.
- When the short distance or targets are crowded, if the gain is reduced, the image can be easily seen.
 - When the long distance, if the gain is increased, it is effective but due to increase of noise, the image becomes hard to be seen.

Result Picture after adjustment by GAIN :

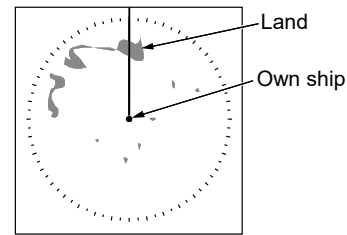

<Picture of too low gain>

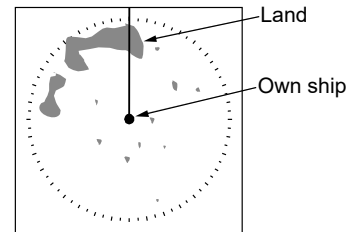

<Picture of adjust gain>

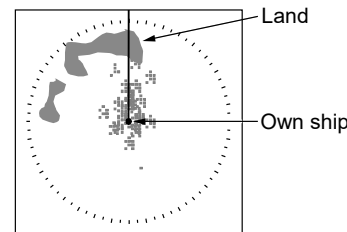

<Picture of too much gain>

Adjustment of Sub-screen Gain

Adjust the right screen (sub-screen) in the PPI/PPI menu.

 For the PPI/PPI screen, refer to 2.4 Display Select.

- 1 Press the [GAIN/PPI] knob.
The GAIN bar moves on the sub-screen.
- 2 When rotating clockwise the [GAIN/PPI] knob, the gain increases.
When rotating counterclockwise the [GAIN/PPI] knob, the gain decreases.

1.8 STC Adjustment

In the short distance menu, even if waves are low and the sea surface is calm, an echo reflected from the sea surface appears in the image.

When waves become high, the sea surface reflected echo covers around the center of the image and make it harder to see targets. Adjust the STC to suppress the reflection from the sea surface so that the image becomes visible easily.

When the [STC/FTC] knob is rotated, the STC bar is displayed. The number in the STC bar varies between 0 and 100. If the STC value does not change when the [STC/FTC] knob is rotated and the FTC value changes, press the [STC/FTC] knob.

STC Adjustment

- 1 When rotating clockwise the [STC/FTC] knob to increase the S bar value, the reflection suppressing effect becomes stronger.
- When not influenced by waves, rotate fully counterclockwise the [STC/FTC] knob.
- This function reduces the gain at short distance. If rotating clockwise the [STC/FTC] knob too much, desired targets disappear.

Picture after adjustment by STC:

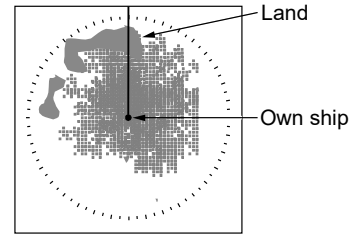

<Picture with sea clutter>

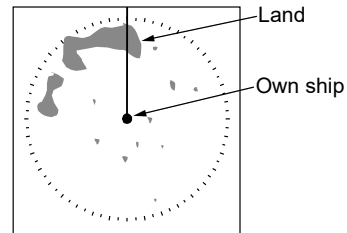

<Picture of adjusted STC>

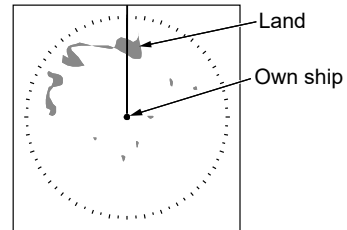

<Picture of too much STC>

In the PPI/PPI menu, when rotating the [STC/FTC] knob, the STC functions effective in both displays.

1.9 FTC Adjustment

When raining or snowing, due to reflection from rain or snow, an object is hard to be seen. By increasing the set value of FTC, the contour of an object, which was concealed by an image of rain or snow, appears. But, you may miss a small object. (Normally, set the FTC to 0.)

When the [STC/FTC] knob is rotated, the FTC bar is displayed. The number in the FTC bar varies between 0 and 100. If the FTC value does not change when the [STC/FTC] knob is rotated and the STC value changes, press the [STC/FTC] knob.

Result picture after adjustment by FTC

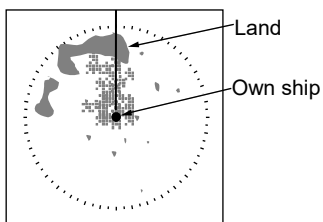

<Picture with rain clutter>

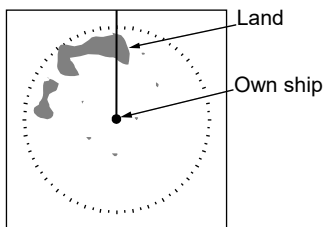

<Picture with rain reflex suppressed>

- 1 Press the [STC/FTC] knob.
- 2 When rotating clockwise the [STC/FTC] knob to increase the F bar value, the reflection suppressing effect becomes stronger.

1.10 Setting of OFF CENTER

When viewing widely in the heading, use this function.

Setup: OFF, ON (Initial value: OFF)

- 1 Press the [OFF CENT] key
- 2 Change the setting of [OFF CENTER] to [ON] with the [▲] and [▼] keys.
It moves to the off center position where the own ship point is stored

OFF CENTER
OFF
ON

- 3 Press the [▶] key.
 - 4 Move the cursor to the point you desire to move your ship with the [▲], [▼], [◀] [▶] keys.
 - 5 Press the [ENT] key.
Own ship's position moves to the position of the cursor.
- The movable range is limited.
(See the movable range shown below.)

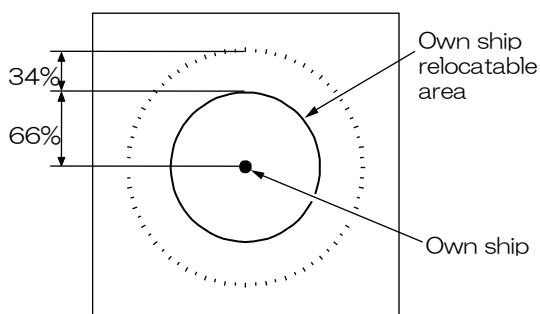

- When [PPI/PPI] or [PPI/NAV] is selected in [DISPLAY SELECT] and TM is selected in [MODE], the off-center cannot be executed.

1.11 Setting of Enhance (Enlarged Target)

If a target is too small to see, the target can be enlarged to make it easier to see it.

Setup: OFF, 1, 2 (Initial value: OFF)

- 1 Press the [ENH] key, the enhance value changes.
- 2 The greater the numeral is, the larger the target is enlarged.

1.12 EBL

This mode is used when measuring the bearing from own ship to a target.

Setup: OFF, ON (Initial value: OFF)

- 1 Press the [EBL] key.
- 2 The EBL rotates clockwise with the [▶] key and counterclockwise with the [◀] key.
The bearing indicated by the EBL is shown at the lower left side of the display.

1.13 VRM

This mode is used when measuring a distance from own ship to a target.

Setup: OFF, ON (Initial value: OFF)

- 1 Press the [VRM] key.
- 2 The VRM moves in the far direction with the [▲] key and in the near direction with the [▼] key.
The distance indicated by the VRM is shown at the lower right side of the display.

1.14 Use of Function keys

The following functions can be assigned to the [F1] - [F6] keys.

- [MODE]
- [DISPLAY SELECT]
- [TRAIL TIME]
- [COLOR]
- [PI]
- [ALARM MODE]
- [ACQ]
- [DELETE]
- [POB]
- [TARGET]
- [OTHER SHIP]
- [PULSE]
- [PROCESS]
- [CAMERA DISPLAY]
- [OFF]*

When selecting [OFF], the key operation of [F] will be invalid.

How to use [F1] - [F6] keys

When pressing the [F1-6] key, the assigned function works.

Function	Operation
MODE	When pressing the [F1-6] key, the display mode changes.
DISPLAY SELECT	When pressing the [F1-6] key, the display changes.
TRAIL TIME	When pressing the [F1-6] key, the trail time changes.
COLOR	When pressing the [F1-6] key, the display color changes.
PI (Parallel Index Line)	After pressing the [F1-6] key, the display of parallel cursor changes to the one side/both sides/OFF. After pressing the [▶] key to the one side/both sides, change the interval with the [▲] / [▼] keys and then the bearing with [◀] / [▶] keys.
ALARM MODE	After pressing the [F1-6] key, if the [▲] or [▼] key is pressed, the alarm mode changes to the IN/OUT/OFF. When selecting the In/Out, if the [▶] key is pressed, the mode enters in the alarm range set state.
ACQ(Acquire)*	When pressing the [F1-6] key, a target aligned with the cursor is acquired.
DELETE*	In case of selecting [NUMBER] in the menu, if the [F1-6] key is pressed, the numeral selection menu appears.

	Select the number of the desired capture to be released with [▲] / [▼] keys and press the [ENT] key to set it. In case of selecting [CURSOR] in the menu, if the [F1-6] key is pressed, the capture of a target aligned with the cursor is released.
POB***	The position of own ship at the moment when the [F1-6] key is pressed is stored as a POB position. In the state that the POB position is stored, if the [▲] or [▼] key is pressed after pressing the [F1-6] key, the setup of renewal/release of the POB position can be changed. The renewal or release of the POB position can be performed with the [ENT] key.
TARGET***	The position of cursor at the moment when pressing the [F1-6] key is outputted to the external terminal with the TLL sentence.
OTHER SHIP **	When pressing the [F1-6] key, the information of a target aligned with the cursor is displayed in the window.
PULSE	When pressing the [F1-6] key, the pulse width changes.
PROCESS	When pressing the [F1-6] key, the process changes.
CAMERA DISPLAY	Press the [F1-6] key with the CCD set. The video of a CCD camera appears. A split-screen display, a full screen display and non-display are toggled by pressing the [F1-6] key.

- * The ATA board (optional) is required.
- ** The AIS interface board / cable (optional) or ATA board (optional) is required.
- *** Inputting the bearing, the latitude and longitude data is required.

1.15 Use of Cursor

The cursor can move freely on the radar screen. According to moving of the cursor, the cursor position, distance and bearing from own ship are displayed.

- 1 Press any of [▲], [▼], [◀] and [▶]. The cursor moves and the cursor information is displayed.

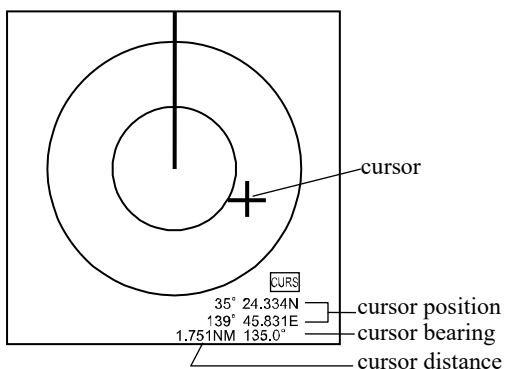

1.16 Measuring the distance and bearing between two points

The distance and bearing between two points, you desire, can be measured, using the cursor.

How to operation

- 1 Move the cursor to one point desired with the [▲], [▼], [◀] and [▶] keys.
- 2 Press the [ENT] key to set it as an origin.
- 3 When moving the cursor with the [▲], [▼], [◀] and [▶] keys, the distance and bearing from the origin to the position of the cursor are displayed.
- 4 When pressing the [MENU] key, the 2-point calculation is finished.

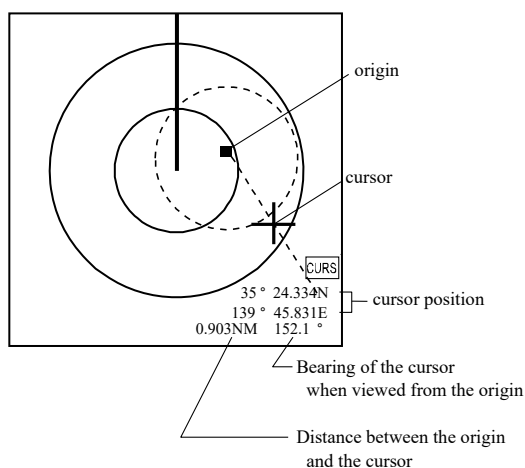

1.17 Camera Display

The video of the CCD camera can be displayed on the radar screen. (CCD camera: Prepared by a customer)

How to connect the CCD camera

- 1 Connect CW-405-0.3M cable (optional cable) to the J6 in the rear connectors.
- 2 Connect a commercially available CCD camera to the cable.

How to display the video of the CCD camera

- 1 Press the [F1-6] key with the CCD set. The video of the CCD camera appears. A split-screen display, a full screen display and non-display are toggled by pressing the [F1-6] key.
- 2 When pressing the [◀] or [▶] key in the state that a video of the CCD camera is displayed, the display position of the video of the camera video can be corrected.
- 3 When displaying the video of the CCD camera, if a key other than the [STBY/TX],[RANGE], [◀] and [▶] keys is pressed, the video of the CCD camera disappears.

Caution



When displaying the video of the CCD camera, the display area of the radar image is narrowed. When set to [Full Screen Display], the radar image is completely concealed. When displaying the video of the CCD camera, pay attention to the display area.

Chapter 2 How to use the menu

2.1 How to operate the menu

Display/Non-display of Menu

- 1 Press the [MENU] key.
The displays of the menu and the explanation of operation are displayed.

ECHO	Cursor	Setting item column
TRAILS	MODE	H UP RM
DISPLAY	DISPLAY SELECT	PPI
ALARM	PROCESS	OFF
AIS	PULSE	RESO-P PRI
ATA		
NEXT		

Menu column

When [Operation Guide] is set to ON, the explanation of operation appears.
 See 3.2 Setting of Assist Items.

GUIDE	
-------	--

- 2 Press the [MENU] key, the display of the menu and the explanation of operation close.

Operation of Menu

- 1 When the menu is displayed, select a menu name with the [▲] and [▼] keys.
According to the selected menu, contents in the setup items at the right side change.

ECHO	TRAIL MODE	OFF
TRAILS	TRAIL TIME	3MIN
DISPLAY	TRAIL SHAPE	STANDARD
ALARM	TRAIL LEVEL	7
AIS		
ATA		
NEXT		

- 2 Press the [▶] key.

- 3 Select an item you desire to change with the [▲] and [▼] keys.

ECHO	TRAIL MODE	REL
TRAILS	TRAIL TIME	3MIN
DISPLAY	TRAIL SHAPE	STANDARD
ALARM	TRAIL LEVEL	7
AIS		
ATA		
NEXT		

- 4 Press the [▶] key.
According to the selected item, the setup menu appears.

TRAIL MODE
REL
TRUE

FIELD OF ANGLE
5

PI NUMBER
7
1 ~ 7

- 5 Change contents of setup with the [▲] and [▼] keys.
- 6 Press the [◀] key. Then, the cursor returns to the setup item column.
- 7 To select another menu name, press the [◀] key.
The cursor returns to the menu column.
- 8 Press the [MENU] key to close the menu.

Caution



- Unless the AIS interface board is equipped, you cannot operate the AIS menu.
- Unless the ATA board is equipped, you cannot operate the ATA menu.

2.2 Setting of Display Mode

In the display mode, the bearing and the target motion are displayed in combination.

Setup: H UP RM, N UP RM, N UP TM, C UP RM, C UP TM, WPT UP RM (Initial value: H UP RM)

- 1 Press the [MENU] key.
- 2 Select [ECHO] → [MODE].

3 Change the setting of [MODE] with the [▲] and [▼] keys.

4 Press the [MENU] key to close the menu.

Four bearing displays of [H UP], [N UP], [C UP] and [WPT UP] are provided.

[NUP] and [SUP] can be swapped.

☞ Refer to [N UP/S UP] in 3.2 Setting of Assist Items.

Two types of display method “RM” and “TM” are provided for the motion display.

- Entering the bearing data for C UP, N UP “RM” is required.
- Entering the bearing, speed and latitude/longitude data for C UP, N UP “TM” is required.
- Entering the WPT data for WPT UP is required.

Your ship heading is assumed 45° in the following description of each mode.

H UP (Head Up)

The H UP is the display mode to orient the heading to the top of the screen.

In this mode, the heading is used as a reference and the screen image, which is similar to the visibility when navigating your ship, can be seen. Therefore, this mode is suitable for watching targets.

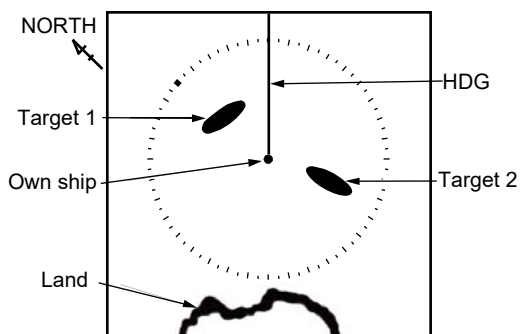

N UP (North Up)

The N UP is the display mode to orient the true north to the top of the screen.

Due to the true north oriented display, the screen image can be easily compared with a chart with a north oriented representation.

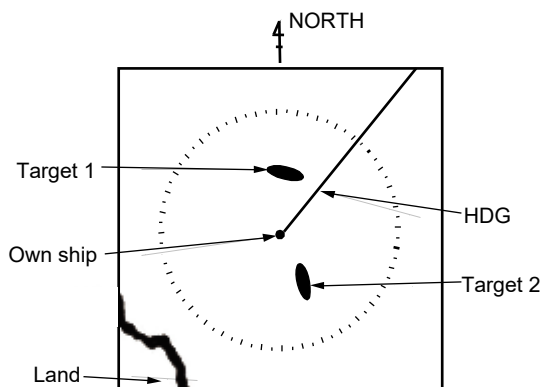

When selecting the S UP (South Up), the true south is oriented to the top of the screen.

C UP (Course Up)

The C UP is the display mode in which the heading becomes the set course instantly when [C UP] is selected and the set course is oriented to the top of the screen.

When navigating your ship along the planned course, use this mode. If your ship is off the planned course, it visually shows the deviation from the planned course.

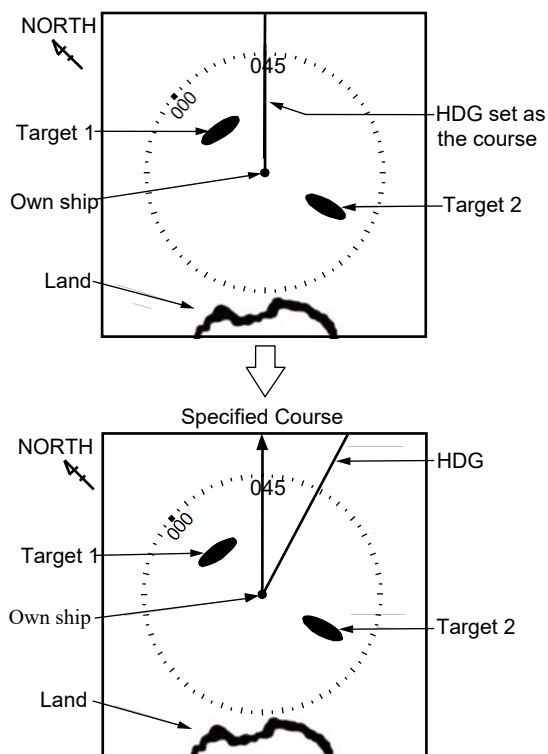

WPT UP (Waypoint Up)

The WPT is the display mode to always orient the WPT to the top of the screen. When this mode is used in combination with the course up function of the plotter, the understandable image is available.

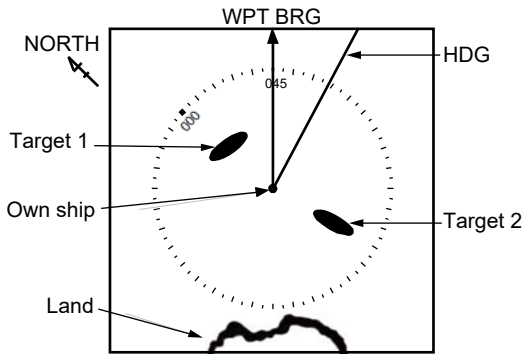

Relative Motion (RM) and True Motion (TM)

The relative (RM) motion mode indicates motions of surrounding targets while fixing your ship's position at the center of the display. As the own ship's position is placed at the center of the display, the fixed targets such as the land move on the screen when the ship navigates.

The true (TM) motion indicates the motion of targets with respect to the specified bearing. Fixed targets, which do not move in any directions, stay on the screen, and all moving targets move on the screen.

Caution  No true motion [TM] is provided for [H UP] mode as the constantly moving heading is used as a reference. The true motion [TM] is also not provided for [WPT UP] which uses the specified course as a reference.

Caution  In [TM] mode, entering the data of the bearing, speed and latitude/longitude is required.

Relative motion (RM): The own ship is fixed and other surrounding targets move on the screen. This is useful when monitoring the surrounding situation based on your own ship's position.

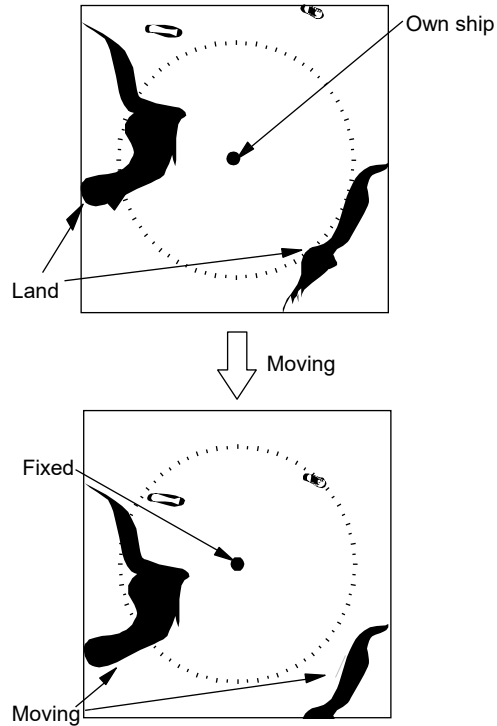

True motion (TM): Your ship moves according to its speed and tidal current on the screen. Stationary targets are fixed on the screen. It is useful when monitoring your ship's position with respect to the fixed targets such as land.

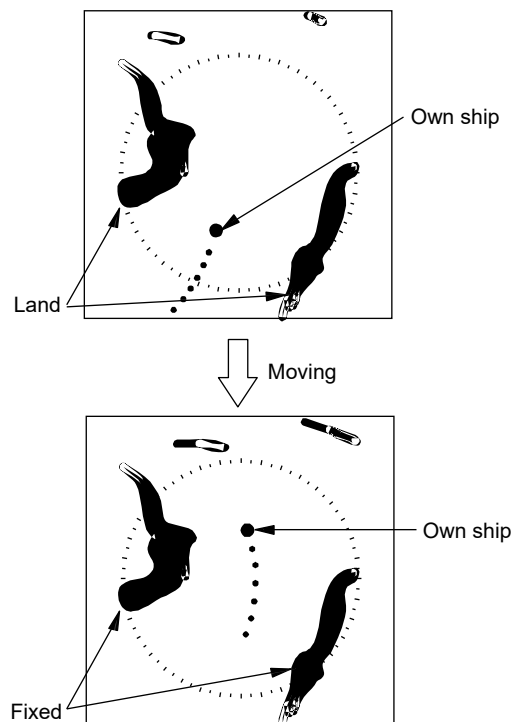

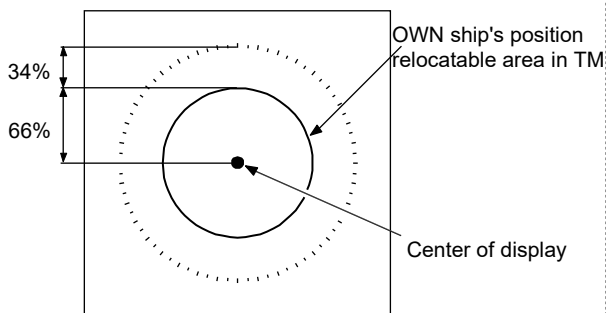

True Motion Reset

When your ship exits from movable range of your ship's position, it moves to the opposite side within the range.

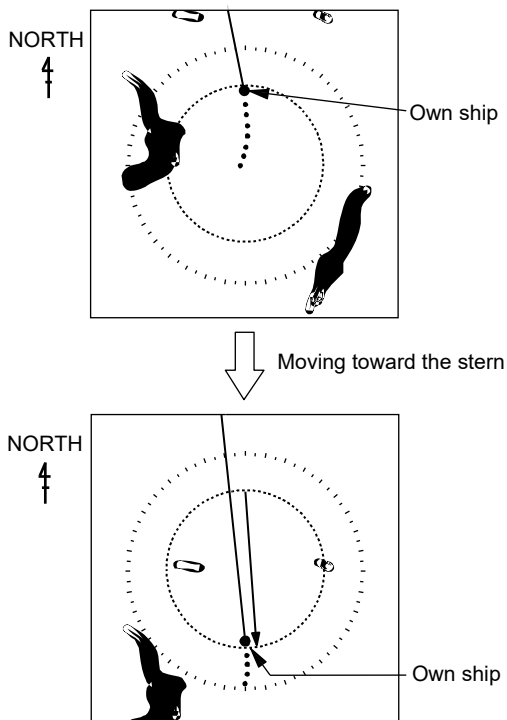

2.3 Display Select

The display selection designates the combination of the radar image to be displayed.

Setup: PPI, PPI/PPI, PPI/NAV (Initial value: PPI)

- 1 Press the [MENU] key
- 2 Select [ECHO] → [DISPLAY SELECT].
- 3 Change the setting of [DISPLAY SELECT] with the [▲] and [▼] keys.

DISPLAY SELECT
PPI
PPI / PPI
PPI / NAV

- 4 Press the [MENU] key to close the menu.

PPI Display

The radar screen is displayed on the entire display.

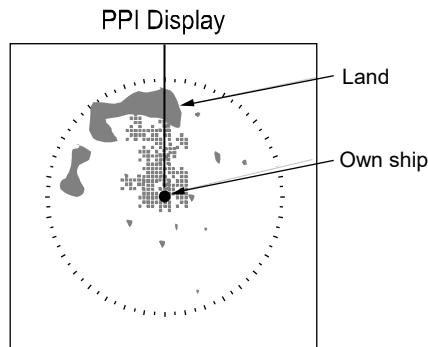

PPI/PPI Display

Two radar images are displayed in the left (main screen) and right (sub-screen) halves of the screen. The screen is switched every two rotation of the antenna.

The images of two different ranges can be displayed.

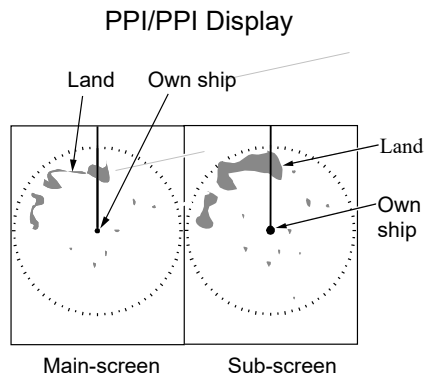

The range of the left display (main-screen) can be changed with the [- RANGE +] key. The gain of the left display (main screen) can be adjusted by rotating the [GAIN/PPI] knob. The range of the right display (sub-screen) can be changed with the [- SUB RANGE +] key. The gain of the right display (sub-screen) can be adjusted by rotating the [GAIN/PPI] knob after pressing the [GAIN/PPI] knob. Other setting items are used in common in the main-screen and sub-screen.

Note on PPI/PPI Display

In the PPI/PPI display, to avoid risk, the following functions do not work.

- TM (True Motion)
- Off center
- Trailing
- ATA (Optional)
- W UP

The EBL, VRM and PI (parallel cursor) can be displayed only in the main-screen.

PPI/NAV Display

The radar image is displayed in the left half of the screen and the navigation data is displayed in the right half of the screen.

The content of the navigation data display can be selected.

 For the NAV Display Select, refer to [NAV Display Select] in 3.5 Preset.

Note on PPI/NAV Display

In the PPI/NAV display, to avoid risk, the following functions do not work.

- TM (True Motion)
- Off Center

2.4 Setting of Signal Process

If the reflection from a target you desire to see is unstable, the target is stabilized by rendering the signal process.

Setup: OFF, ON (Initial value: OFF)

- 1 Press the [MENU] key,
- 2 Select [ECHO] → [PROCESS].
- 3 Change the setting of [PROCESS] with the [▲] and [▼] keys.
- 4 Press the [MENU] to close the menu.

2.5 Setting of Pulse Width

The short pulse width is suitable for target crowded area. (The resolution is of high priority.)
The long pulse width is suitable for searching a small target as the gain increases. (The gain is of high priority.)

Setup: RESO-P PRI. GAIN PRI. (Initial value:

GAIN PRI.)

- 1 Press the [MENU] key.
- 2 Select [ECHO] → [PULSE].
- 3 Change the setting of [PULSE] with the [▲] and [▼] keys.
- 4 Press the [MENU] key to close the menu.

The setup of the pulse width is determined by the range.

The setup of the present pulse width is displayed at the left top side of the screen.

SP < M1 < M2 < L1 < L2
(Narrowest) (Widest)

 For pulse width adjustment, refer to [Pulse Width] of 3.3 Setting of Adjustment Item.

2.6 Trailing

By leaving the trail of a target, the situation of the moving target can be seen.

- 1 Press the [MENU] key.
- 2 Select [TRAILS] → [TRAIL MODE].
- 3 Change the setting of [TRAIL MODE] with the [▲] and [▼] keys.
- 4 Select [TRAILS] → [TRAIL TIME].
- 5 Change the setting of [TRAIL TIME] with the [▲] and [▼] keys.
- 6 Press the [MENU] to close the menu.

For the display method, the relative display (R) and the true display (T) are provided.

When changing the range, display mode or display select, the trail disappears.

Relative Display (R)

The relative speed of a target with respect of own ship is displayed as a trail.

This is used to watch a target which is approaching to own ship. The trail of fixed target such as land, if own ship is moving, will be drawn.

In the illustration below, own ship is moving east at a certain speed and other ship 1 is moving east at the identical speed. And other ship 2 is moving west at the identical speed. After a certain period of time, the trails of three ships are drawn.

The relative speed of a target with respect to own ship is drawn as a trail. Since the ship 2 is moving in the opposite direction at the identical speed, the speed derived by adding the ship 2 speed and own ship speed is drawn as a trail. The land is drawn as a trail of own ship speed as the land moves at the own ship speed.

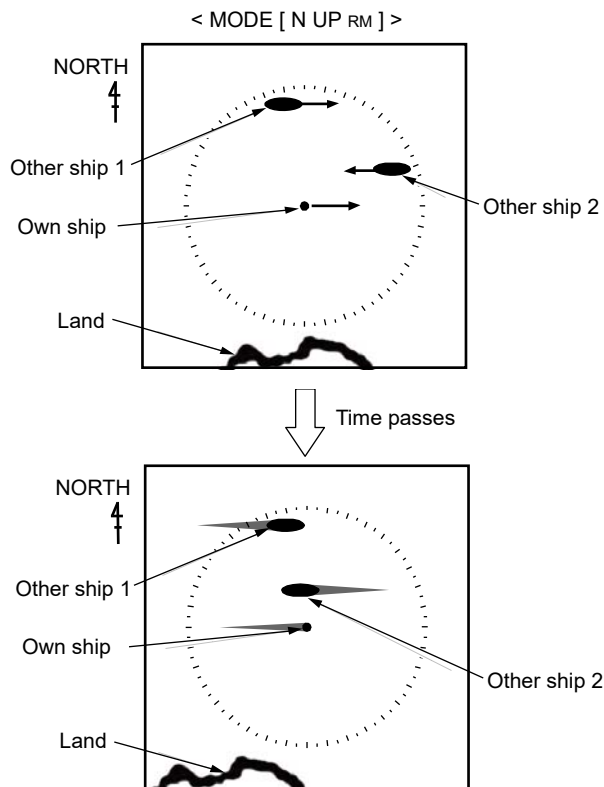
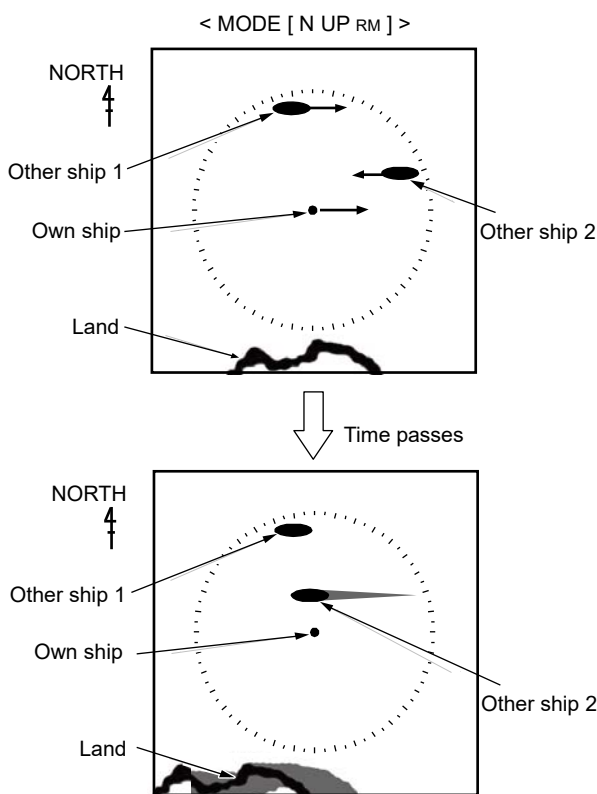

The length of the trail display is specified in [TRAILS] → [TRAIL TIME]. The length is specified by a time, and “One minute” indicates the trail of past one minute. When selecting [OFF], the trail is not displayed.

The shape of trail display is specified in [TRAILS] → [TRAIL SHAPE]. When [STANDARD] is selected, the trail shape of a target does not change as time goes. When [DECREMENT] is selected, the shape of a target becomes narrower as time goes.

The signal level of a target which is left as a trail is specified in [TRAILS] → [TRAIL LEVEL]. By increasing the numeral, only trails of strongly reflected targets can be displayed. By decreasing the numeral, trails of weakly reflected targets can be displayed.

True Display (T)

Irrespective of the motion of own ship, trails representing the course and speed of moving targets are drawn. This mode is used to monitor the courses and speeds of moving targets. The fixed target such as land is not drawn.

The trails of speeds of own ship, other ship 1 and other ship 2 are drawn. No trail of the land is drawn as it does not move.

2.7 Display Color

When the display is hard to see due to the environment, changing the color of the display makes it easier to see the contents.

Setup: STANDARD, DAY, NIGHT, USER SET (Initial value: STANDARD)

- 1 Press the [MENU] key.
- 2 Select [DISPLAY] → [COLOR].

- 3 Change the setting of [COLOR] with the [▲] and [▼] keys.
When selecting [DAY], the color of the entire display changes so that it can be seen under the direct sunlight.
When selecting [NIGHT], the display changes to the color suitable for use at night.
When selecting [USER SET], the display changes to the color user can set to preference while STANDARD, DAY, NIGHT remain unchanged.
- 4 Press the [MENU] key to close the menu.

2.8 Cursor Shape

The shape of the cursor can be changed. In [LONG], the vertical and horizontal lines of cursor can be extended to the end of display. It is suitable for grasping the relationship between two remote points.

In [EBL + VRM], the cursor is the combination of [EBL] + [VRM].

It is suitable for grasping the relationship between own ship and the target.

Setup: STANDARD, LONG, EBL+VRM (Initial value: STANDARD)

- 1 Press the [MENU] key.
- 2 Select [DISPLAY] → [CURSOR SHAPE].
- 3 Change the setting of [CURSOR SHAPE] with the [▲] and [▼] keys.
- 4 Press the [MENU] key to close the menu.

2.9 PI (Parallel Index Line)

The straight lines parallel with own ship are displayed.

Setup: OFF, ONE SIDE, BOTH SIDES (Initial value: OFF)

- 1 Press the [MENU] key.
- 2 Select [DISPLAY] → [PI].
- 3 Change the setting of [PI] with the [▲] and [▼] keys.

PI
OFF
ONE SIDE
BOTH SIDES

- 4 After selecting [ONE SIDE] or [BOTH

SIDES], press the [▶] key. Then, the parallel cursor can be operated. The distance between parallel lines can be changed with the [▲] and [▼] key and the bearing can be changed with the [◀] and [▶] key.

- 5 Press the [MENU] key to close the menu.
Set a number of parallel lines in [DISPLAY] → [PI NUMBER].

2.10 Bearing Mode

This mode is used when changing the bearing display mode of cursor and EBL.

One setting is the true bearing with the true north set to 0°. The other setting is the relative bearing with the heading set to 0°.

Setup: REL, TRUE (Initial value: REL)

- To display in the true bearing mode, entering the bearing is required, using the optional GPS compass or others.
- 1 Press the [MENU] key.
 - 2 Select [DISPLAY] → [BRG TRUE/REL].
 - 3 Change the setting of [BRG TRUE/REL] with the [▲] and [▼] keys.
 - 4 Press the [MENU] key to close the menu.

2.11 Vector

The vector means arrow that represents heading and speeds of own ship and other ships.

The bearing indicated by the arrow denotes the heading and the length of arrow denotes the speed.

The length is specified by time "One minute" shows the positions of own ship and other ships after one minute.

Setup: 0 to 60min (Initial value: 1min)

- 1 Press the [MENU] key.
- 2 Select [DISPLAY] → [VECTOR].
- 3 Change the setting of [VECTOR] with the [▲] and [▼] keys.
- 4 Press the [MENU] key to close the menu.

The bearing mode of the vector line is specified in [DISPLAY] → [VECTOR TRUE/REL].

2.12 Alarm

This mode is used when monitoring targets. When targets enter in the set range or exit from the set range, the buzzer notifies. Two types [IN] and [OUT] are provided for the alarm mode.

IN Mode

When a target enters within the specified range, the alarm is issued. This mode is used when watching targets which are approaching to own ship.

OUT Mode

When a target exits from the specified range, the alarm is issued.

Setting of Alarm Range

- 1 Press the [MENU] key.
- 2 Select [ALARM] → [ALARM MODE].
- 3 Change the setting of [ALARM MODE] with the [▲] and [▼] keys.

ALARM MODE
OFF
IN
OUT

- 4 After selecting [IN] or [OUT], press the [▶] key. Then, the alarm range can be set.
- 5 Move the cursor to the center of the alarm range with the [▲], [▼], [◀] and [▶] keys.
- 6 Press the [ENT] key.
- 7 Change the distance direction with the [▲] and [▼] keys and the bearing with the [◀] and [▶] keys.
- 8 Press the [ENT] key. Then, the alarm range is set.
- 9 Press the [MENU] key to close the menu.

The level of targets for alarm is set in [ALARM] → [DETECT LEVEL]. The alarm works when detecting the level higher than the set level.

When [DETECT COUNT] is set, the alarm works depending on the [ALARM MODE] setting.

[IN Mode]: The alarm works when targets enter continuously into alarm area more than

[DETECT COUNT] value.

[OUT Mode]: The alarm works when targets leave continuously from alarm area more than [DETECT COUNT] value.

2.13 Sleep

The power OFF state and the transmitting state are alternately repeated. This mode saves the power consumption. The sleep is used in combination with the IN/OUT alarm.

☞ For the setting of the alarm, refer to 2.17 Alarm.

Setup: OFF, 5MIN, 10MIN, 15MIN, (Initial value: OFF)

- 1 Press the [MENU] key.
- 2 Select [ALARM] → [SLEEP].
- 3 Change the setting of [SLEEP] with the [▲] and [▼] keys.
- 4 Press the [ENT] key to close the menu.

Operation during executing the sleep

During executing the sleep, the transmitting for 30 seconds is repeated at the interval of the set time. If the IN/OUT of a target occurs during transmitting, the buzzer beeps for alarm.

In case that the set time is set to 5 minutes, the sleep works as follows.

Time	30 sec.	2 min. 30 sec.	2 min.	30 sec.	→Hereafter repeated
Antenna	Transmitting	Power OFF	Power On (Countdown)	Transmitting	

2.14 AIS

By installing the optional AIS interface board, the information on other ships, which are received by the AIS receiver, can be displayed.

The other ship symbols of up to 100 ships can be displayed.

Caution As the AIS is optional, the menu becomes valid when the AIS interface board is installed.

Setting of Symbol Display of AIS

- 1 Press the [MENU] key.
- 2 Select [AIS] → [AIS].
- 3 Change the setting of [AIS] with the [▲] and [▼] keys.
- 4 Press the [MENU] key to close the menu.

To change the region to display the other ship's symbol, set it in [AIS] → [LIMIT]. Only other ship's symbols within the radius of the set distance from own ship placed in center can be displayed.

Setting of Detailed Information of Designated Symbol Display

The information display is set in [AIS] → [INFO], [INFO NUMBER]. The other ship's information of the designated number is displayed at the bottom of the display.

- 1 Press the [MENU] key.
- 2 Select [AIS] → [INFO].
- 3 Change the setting with the [▲] and [▼] keys.
- 4 Select [AIS] → [INFO NUMBER].
- 5 Select the number with the [▲] and [▼] keys.
- 6 Press the [MENU] key to close the menu.

Types and Meanings of AIS Symbols

In the AIS, the symbols are displayed, overlaying them on other ships from which the information is derived.

Normal Symbol	Meanings
	Sleep Display* Displays ships of which information display is not performed.
	Active Display** Displays ships which are performing the information display or after performing it. The dotted line denotes the speed and the real line denotes the heading. The line perpendicular to the heading direction denotes the course direction.
	Displays ATON (Aids to navigation) and Base.
	Displays ships while selecting the detailed information display. The detailed information display is shown at the bottom of the display.
Alarm Symbol	Meanings
	Displayed when the values are lower than the set CPA and TCPA, and get alarm.
	Displays lost ships during tracking. In case those ships are lost from the sleep, the alarm does not sound and they disappear from the screen.

* : When active target gets out of the screen and again into the screen, the target automatically changes to sleep target. (The above could be happen at the time of target vessel moving out, RANGE shifting, and OFF-CENTER shifting.)

** : To change from the sleep display to the active display, after setting ON in [AIS] → [INFO], change the number in [AIS] → [INFO NUMBER].

Or register [OTHER SHIP] to [F1]-[F6] key, and place the cursor to the target you would get the information and press [F1]-[F6] key.

Warning The accuracy of the data provided by the AIS could be affected by the following factors:

Degraded bearing data and latitude/longitude from external sensor devices cause erratic vectors. If any error data fed from external sensor devices are detected, the following data provided by the AIS display will be also erratic.

- The CPA and TCPA value and Alarm.
- The target ship's course and speed.
- The target ship's bearing and distance.

2.15 ATA

To use the ATA, install the optional ATA board. The ATA automatically tracks targets and stores and displays their courses and speeds as vectors.

Entering the heading bearing and ship speed are required, using the optional GPS compass or others.

After tracking, targets are displayed as a vector of course and speed.

An object, which is acquired and tracked, is called a target.

Caution  As the ATA is optional, the menu becomes valid only when the ATA board is installed.

To activate ATA, the bearing and the speed information of own ship needs to be input. The bearing signal shall be such high speed and highly accurate signals as from GPS COMPASS. GPS bearing only tends not to be enough to operate ATA normally.

Warning



The accuracy of the auto tracking function provided by the ATA could be affected by the following factors:

- (1) Sea clutter and weather clutter such as rain and snow may degrade the ATA tracking capability. These clutter components should be appropriately reduced.
- (2) Poor receiver sensitivity may also degrade the tracking capability.
- (3) Faulty azimuth synchronization could be the cause of erratic vectors.
- (4) Degraded bearing and speed data fed from external sensor devices also cause erratic vectors.

If any of the errors stated above are detected, the following data provided by the ATA will be erratic.

- The CPA, TCPA value and Alarm.
- The target ship's course and speed.
- The target ship's bearing and distance.

Automatic Acquisition

Targets entering in the preset range can be automatically acquired.

- 1 Press the [MENU] key.
- 2 Select [ATA] → [AUTO DETECT AREA].
- 3 Change the setting of [AUTO DETECT AREA] with the [▲] and [▼] keys.



- 4 After selecting ON, press the [▶] key. Then, the automatic acquisition range can be set.
- 5 After moving the cursor to the center of [AUTO DETECT AREA] with the [▲], [▼], [◀] and [▶] keys.
- 6 Press the [ENT] key.
- 7 Change the distance with the [▲] and [▼] keys and bearing with the [◀] and [▶] keys.
- 8 Press the [ENT] key. Then, the [AUTO DETECT AREA] is set.
- 9 Press the [MENU] key to close the menu.

Manual Acquisition

Direct to acquire a target by designating a target on the display.

- 1 Press the [MENU] key.
- 2 Select [ATA] → [ACQ].
- 3 Press the [▶] key.
- 4 Align the cursor with a target you desire to acquire with the [▲], [▼], [◀] and [▶] keys.
- 5 Press the [ENT] key. Then, the acquisition of the designated target is started.
- 6 When acquiring several targets, repeat steps 4 and 5.
- 7 Press the [MENU] key to close the menu.

Target Level

The signal level of a target to be automatic/manual-acquisition is specified in [ATA] → [ATA TGT LEVEL].
By increasing the numeral, a strongly reflected target can be acquired.
By decreasing the numeral, a weakly reflected target can be also acquired.

Target Delete

Release the acquisition of a target.

- 1 Press the [MENU] key.
- 2 Select [ATA] → [DELETE].
- 3 Press the [▶] key.
- 4 Change the setting of [DELETE] with the [▲] and [▼] keys.

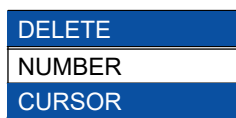

- 5 After selecting [NUMBER] or [CURSOR], press the [▶] key. Then, the number designation or the cursor designation can be set.
- 6
 - In case of [MAN ACQ NUM], change the number to be deleted with the [▲] and [▼] keys.
 - In case of [CURSOR], align the cursor with the target you desire to delete with the [▲], [▼], [◀] and [▶] keys.
- 7 Press the [ENT] key. Then, the acquisition of the designated target is released.
- 8 When releasing acquisition of several targets, repeat steps 6 and 7.
- 9 Press the [MENU] key to close the menu.
To release acquisition of all targets, execute [ATA] → [ALL DELETE].

Number of Acquisition

A total number of targets to be acquired is 50 targets when combined in both automatic/manual methods.
The number specified in [ATA] → [MAN ACQ NUM] becomes a number of targets to be manually acquired. And the rest becomes a number of targets to be automatically acquired.

- 1 Press the [MENU] key.

- 2 Select [ATA] → [MAN ACQ NUM].
- 3 Change the setting of [MAN ACQ NUM] with the [▲] and [▼] keys.
- 4 Press the [MENU] key to close the menu.

Information Display

The information display is set in [ATA] → [INFO] or [INFO NUMBER].
The target information of the designated number is displayed at the bottom of the display.

- 1 Press the [MENU] key.
- 2 Select [ATA] → [INFO].
- 3 Change the setting with the [▲] and [▼] keys.
- 4 Select [ATA] → [INFO NUMBER].
- 5 Select the number with the [▲] and [▼] keys.
- 6 Press the [MENU] key to close the menu.





ATA Performance

The ATA performance is set in [ATA] → [PERFORMANCE].
This is to select the optimum tracking characteristics (calculation process) depending on the purpose of usage, to make the best of the ATA performance.
Select the most suitable setting to the behavior of own ship or target.

Setup: 0 to 7 (Initial value: 0)

Types and Meanings of ATA Symbols

In the ATA, the symbols are displayed, overlaying on acquire-started targets.

Normal Symbol	Meanings
	Displayed when setting the acquisition.
	Displayed when in the stable tracking state.
	Displayed when numeral-displayed after the stable tracking state.
Alarm Symbol	Meanings
	Displayed when the values are lower than the set CPA and TCPA.
	Displayed when targets become in the tracking inability state. After 1 minute, the alarm sounds. After 5 seconds, both the display and the alarm disappear.

NOTE:

The ATA vector and the AIS vector may differ in terms of the vector length and its direction. This is not a fault. The ATA vector is developed based on the past target positions stored either by automatic tracking (ATA). Meanwhile, the AIS vector is generated from the navigation data sent from the AIS transponder. The ATA vector take a certain time until they are fully displayed, while the AIS vector is displayed as soon as the AIS data is received from the AIS transponder and own GPS/SHIP information.

Chapter 3 How to use the system menu

3.1 Display of System Menu

There is a standard menu which is displayed for the first time after pressing the [MENU] key and following a system menu which is not frequently required to change the setup.

- ASSIST
- ADJUST
- NMEA
- PRESET
- MAINTE

Display the system menu

- 1 Press the [MENU] key.
- 2 Select [Next] with the [▲] and [▼] keys.

ECHO	ASSIST
TRAILS	ADJUST
DISPLAY	NM EA
ALARM	PRESET
AIS	MAINTE
ATA	
NEXT	

- 3 Press the [▶] key.
The system menu appears.

PREV	RANGE RINGS	ON
ASSIST	RANGE UNIT	NM
ADJUST	SPEED UNIT	kn
NMEA	TEMP UNIT	°C
PRESET	DEPTH UNIT	m
MAINTE	POSITION DISPLAY	OWN POSITION
	WPT DISPLAY	OFF
	ROTATION SPEED	HIGH SPEED
	NEXT	

Return to the normal menu

- 1 Select [Prev] with the [▲] and [▼] keys.
- 2 Press the [▶] key.
The normal menu appears.

3.2 Setting of Assist Items

In the supplement items of the system menu, to use the radar effectively, the supplement functions are set.

Range Rings

The fixed marker is displayed at the constant distance from own ship's position. It is used as a scale to measure roughly the distance of a target.

Setup: OFF, ON (Initial value: OFF)

Range Unit

Set the unit of distance (range, VRM distance).

Setup: NM, km, sm (Initial value: NM)

Speed Unit

Set the unit of speed.

Setup: kn, km/h, m/h (Initial value: kn)

Temperature Unit

Set the unit of water temperature.

Setup: °C, °F (Initial value: °C)

Depth Unit

The unit of water depth is set.

Setup: m, fm, l.fm, ft, J.fm (Initial value: m)

Position Display

The content of position informatin displayed at the lower left of the display is set.

Setup: OFF, OWN Position, WPT position, POB Position (Initial value: OWN Position)

WPT Display

Select ON or OFF of the WPT icon (flag mark) to be displayed on the radar screen.

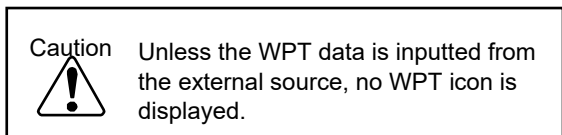

Setup: OFF, ON (Initial value: ON)

Rotation Speed

Set the rotation speed of the radar image by inputting bearing data in the H UP mode or WPT UP mode.

Setup: STANDARD, HIGH SPEED (Initial value: HIGH SPEED)

ALL PPI

Select ON or OFF of the background of numerical information displayed near the image when the PPI display is selected.

Setup: OFF, ON (Initial value: ON)

Guide

Select ON or OFF of the display of operation guide when operating the menu.

Setup: OFF, ON (Initial value: ON)

Buzzer

Set ON or OFF of the buzzer sound. The ON/OFF of external buzzer (optional) sound is also set.

Setup: OFF, ON (Initial value: ON)

Motor Speed

Set the rotational speed of the antenna. During the antenna rotation, the setting cannot be changed.

Setup: OFF, ON (Initial value: OFF)

N UP/S UP

Change the mode of the N UP or S UP of the display mode.

The selected item can be selected in [ECHO] → [MODE].

Setup: N UP, S UP (Initial value: N UP)

Cursor Display

Set the indication methods of the cursor.

When [OPERATING] is selected, cursor is displayed on the radar screen only when operated and disappears 30 seconds after operation is stopped.

Setup: ALWAYS, OPERATING (Initial value: ALWAYS)

Radar Setting Display

Set ON or OFF of the radar setting indication status shown in upper portion of the screen.

When [OFF] is selected, the minimum information required is only displayed on the radar screen.

Setup: OFF, ON (Initial value: ON)

Menu Operation

Select the type of the operation methods in the menu.

Setup: A, B (Initial value: A)

3.3 Setting of Adjustment Items

In the adjustment items of the system menu, when using the radar, the initial adjustment and setup are performed. When setting the adjustment item, set the screen brightness to maximum.

 For screen brilliance, refer to 1.4 Brilliance Adjustment.

Bearing Setting

Adjust the bearing of the radar image on the screen.

Setup: -180.0 to +180.0 (Initial value: 0.0)

- 1 Press the [STBY/TX] key to start the transmission.
- 2 Set the range of the display to more than 1nm with the [- RANGE +] key.
- 3 Press the [MENU] key.
- 4 Move to the system menu.
☞ Refer to 3.1 Display of System Menu.
- 5 Select [ADJUST] → [BRG ADJ].
- 6 Change the setting of [BRG ADJ] with the [▲] and [▼] keys.
When increasing the numeral, the radar image moves clockwise.
When decreasing the numeral, the radar image moves counterclockwise.
Change the bearing so that the bearing of the image of a target becomes the same bearing as measured by the compass.

TX Delay Adjustment

By adjusting the delay time of the transmission, match the distance of the target on the radar screen with the distance of the actual target to adjust precisely, select a nearest hard straight object (pier) (within 100m). Adjust the transmission delay time in the following procedure.

Setup: 0 to 255 (Initial value: 27)

- 1 Press the [STBY/TX] key to start the transmission.
- 2 Set the range of the display to more than 0.125nm with the [- RANGE +] key.
- 3 Press the [MENU] key.
- 4 Move to the system menu.
☞ Refer to 3.1 Display of System Menu.
- 5 Select [ADJUST] → [TX DELAY ADJ].
- 6 Change the setting of [TX DELAY ADJ] with the [▲] and [▼] keys.
When the echo reflected from the target warps to near, decrease the value.
When the echo reflected from the target warps to far, increase the value.
As illustrated below (Figure of center), adjust so that the straight target is straightly

displayed on the screen.

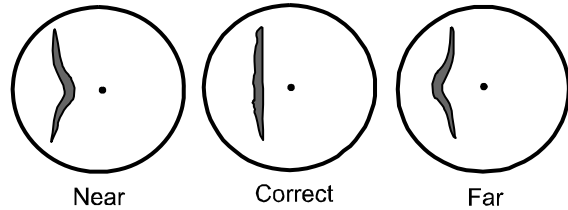

MBS

Set the MBS to suppress and cancel the disc-like transmission leak at the center of the image as shown below.

Setup: 0 to 100 (Initial value: 20)

- 1 Press the [STBY/TX] key to start the transmission.
- 2 Set the [GAIN/PPI] knob to 8, the [STC/FTC] knob to 0.
- 3 Set the range of the display to 0.125nm with the [- RANGE +] key.
- 4 Rotate the [STC/FTC] knob so that the disc-like transmission leak is displayed at the rotational center of the image.
- 5 Move to the system menu.
☞ Refer to 3.1 Display of System Menu.
- 6 Select [ADJUST] → [MBS].
- 7 Change the setting of [MBS] with the [▲] and [▼] keys.
Adjust while observing the disc-like transmission leak.
When the transmission leak disappears, the MBS is best adjusted.

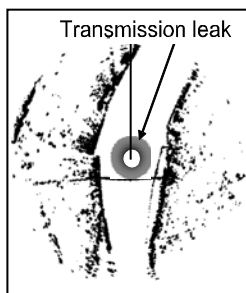

Number of MBS is [Small]

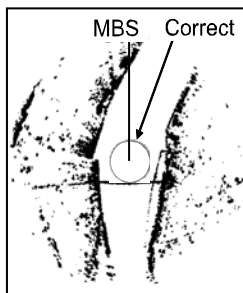

Number of MBS is [Correct]

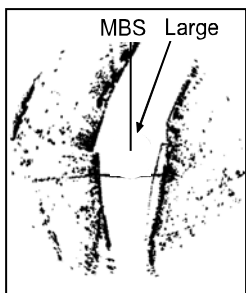

Number of MBS is [Large]

STC Curve

Influence from the ocean surface reflection depends on the installation height of antenna. Please proceed with the following sequence, when STC curve is modified.

Setup: 1 to 8 (Initial value: 4)

Note: Set the STC curve after the gain setting. When setting the STC curve, go out of the harbor and perform at the location where the reflection from sea surface is displayed on the radar screen.

- 1 Set the [GAIN/PPI] knob to 8, the [STC/FTC] knob to 0.
Adjust so that the noise-like sea surface reflected echo is displayed at the center of the image as shown below.

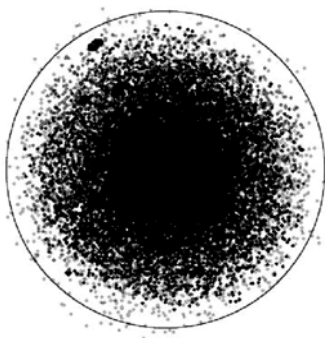

- 2 Press the [- RANGE +] key to select the

range that can display the entire sea surface reflected echo can be displayed.

- 3 Adjust the [STC/FTC] knob and stop it just before the sea surface reflected echo completely disappears (In the state that the sea surface reflected echo is sparsely displayed.) As shown in [Proper] below, when the sea surface reflected echo from near to far distance disappears evenly, the STC curve set value is proper. As shown in [Large], when the sea surface reflected echo at near distance disappear first, or in [Small], when the sea surface reflected echo at far distance disappears first, it is necessary to change the setting in the procedure described in the following items.

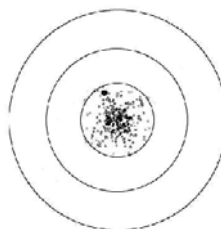

Number of STC Curve is [Small]

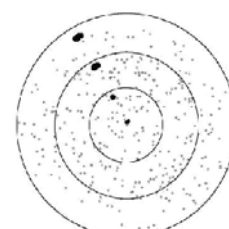

Number of STC Curve is [Correct]

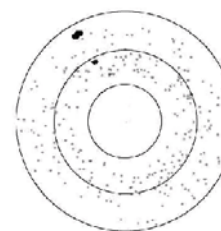

Number of STC Curve is [Large]

- 4 Press the [MENU] key.
- 5 Move to the system menu.
☞ Refer to 3.1 Display of System Menu.
- 6 Select [ADJUST] → [STC CURVE].
- 7 Change the setting of [STC CURVE] with the [▲] and [▼] keys.
When the sea surface reflected echo at near distance disappears first, decrease the value.
When the sea surface reflected echo at far distance disappears first, increase the value.
- 8 Adjust the [STC/FTC] knob again.
Adjust so that the sea surface reflected echo from near to far distance disappears evenly as shown in the illustration [Correct] in step 3.

The STC curve set value is applied to all ranges.

Note: The setting of STC characteristics needs to be performed in the ocean. However, when it is obliged to perform in a harbor, set the STC curve to [4].

Tune Select

Due to an operation environment change, tuning of the transmission frequency with the reception frequency may be detuned. If detuned, the gain will decrease and it is hard to display the image even if setting remains unchanged.

Setup: AUTO, MANUAL (Initial value: AUTO)

Automatic Tuning

For the best performance, when newly installing or replacing the magnetron, the automatic tuning should be adjusted.

Unless the auto tune is adjusted, the optimum gain is not achieved.

Setup: 0 to 100 (Initial value: 31)

- 1 Press the [STBY/TX] key to start the transmission.
- 2 Set the range of the display to more than 12nm with the [- RANGE +] key. Find a large and stable target of more 6nm (mountain or island) at farthest location as possible.
- 3 Adjust by rotating the [GAIN/PPI] knob so that the target is faintly visible.
- 4 Press the [MENU] key.
- 5 Move to the system menu.
☞ Refer to 3.1 Display of System Menu.
- 6 Select [ADJUST] → [TUNE SELECT], and then [AUTO].
- 7 Select [ADJUST] → [AUTO TUNE ADJ].
- 8 Change the setting of [AUTO TUNE ADJ] with the [▲] and [▼] keys. Maximize the size of fixed target on the screen. If the target becomes too large and the best tuning point is lost, reduce the gain with the [GAIN/PPI] knob once to make its size small and maximize the target with the [▲] and [▼] keys.

Manual Tune Adjustment

Due to a sudden environment change, the automatic tuning may be detuned. In this case, use the manual tune adjustment.

Setup: 0.0 to 100 (Initial value: 44.0)

- 1 Press the [STBY/TX] key to start the transmission.
- 2 Set the range of the display to more than 12nm with the [- RANGE +] key. Find a large and stable target of more than 6nm (mountain or island) at farthest location
- 3 Adjust by rotating the [GAIN/PPI] knob so that the target is faintly visible.
- 4 Press the [MENU] key.
- 5 Move to the system menu.
☞ Refer to 3.1 Display of System Menu.
- 6 Select [ADJUST] → [TUNE SELECT], and then [MANUAL].
- 7 Select [ADJUST] → [MANUAL TUNE ADJ].
- 8 Change the setting of [MANUAL TUNE ADJ] with the [▲] and [▼] keys. Maximize the size of fixed target on the screen. If the target becomes too large and the best tuning point is lost, reduce the gain with the [GAIN/PPI] knob once to make its size small and maximize the target with the [▼] and [▲] keys.

Pulse Width

In [2.8 Setting of Pulse Width], [RESO-P PRI.] or [GAIN PRI.] is selected. At this moment, the pulse width (Displayed at the upper left of the display.) can be changed.

This setting can be set for only the range (0.75 to 8).

Setup: SP, M1, M2, L1, L2

- 1 Press the [MENU] key.
- 2 Move the system menu.
☞ Refer to 3.1 Display of System Menu.
- 3 Select [ADJUST] → [PULSE WIDTH].
- 4 Select the range in which the pulse width adjustment is performed with the [▲] and [▼] keys, and press the [▶] key.

- 5 Change the setting of [Pulse Width Adjustment] with the [▲] and [▼] keys.

The content of the set value of [PULSE WIDTH] is as follows.

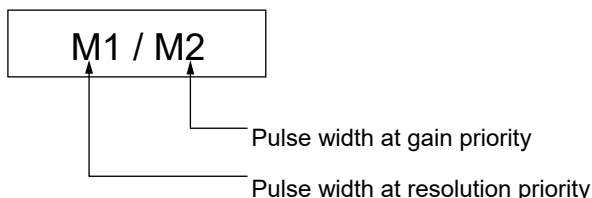

The length of pulse width varies as shown below.

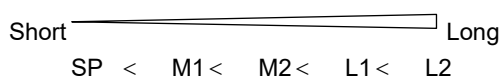

Interference Rejection

This feature is used to eliminate the radar interference wave from other radars. When radars having the same frequency band as your radar are used near your ship, the interference noise from transmission signals of other radars appears on the radar screen. Though the appearance of the interference is not uniform, in most cases, this interference noise pattern is spiral or a radiation form. This unit can reduce the interference with the interference rejection function.

Setup: OFF, 1, 2 (Initial value: 2)

- 1 Press the [MENU] key.
- 2 Move to the system menu.
☞ Refer to 3.1 Display of System Menu.
- 3 Select [ADJUST] → [IR].
- 4 Change the setting of [IR] with the [▲] and [▼] keys.
The greater the numeral is the stronger the interference rejection.
If the interference rejection effect is too strong, it is hard to see small targets.
So be cautious not to set it stronger.

Echo Color Divide

The color of an image can be changed to make it easier to see.

Setup: STANDARD, DETAIL (Initial value: STANDARD)

- 1 Press the [MENU] key.
- 2 Move to the system menu.
☞ Refer to 3.1 Display of System Menu.
- 3 Select [ADJUST] → [ECHO COLOR DIV].
- 4 Change the setting of [ECHO COLOR DIV] with the [▲] and [▼] keys.

[STANDARD]: Standard color

[DETAIL]: Displays many middle colors so that the strength or weakness of the echo can be discriminated.

Signal Select

Select the input signal of the image from antenna, monitor and demo.

Setup: ANTENNA, MONITOR, DEMO (Initial value: ANTENNA)

- 1 Press the [MENU] key.
- 2 Move to the system menu.
☞ Refer to 3.1 Display of System Menu.
- 3 Select [ADJUST] → [SIGNAL SELECT].
- 4 Change the setting of [SIGNAL SELECT] with the [▲] and [▼] keys.

[ANTENNA]: In case that the input signal of the image is antenna:

[MONITOR]: In case that two units are connected and used as a monitor

[DEMO]: The Fixed video is displayed.

3.4 NMEA

In the NMEA item of the system menu, the transmission speed of the external input/output can be changed.

Match the transmission speed with that of the external connection equipment.

- 1 Press the [MENU] key.
- 2 Move to the system menu.
☞ Refer to 3.1 Display of System Menu.
- 3 Select [NMEA] → [CH1 (J5)], [CH2 (OP1)] or [CH3 (OP2)].
Select the connector of which the transmission speed is changed.
- 4 Change the setting of transmission speed with the [▲] and [▼] keys.

- 5** Press the [▶] key to display the NMEA monitoring menu.
If the external equipment is connected at the correct transmission speed, the received NMEA sentence is displayed.

 For the NMEA sentence, refer to 5.6 List of Input/Output sentence.

Connection with the KODEN GPS compass

In case KGC-1/KGC-222 is connected to CH1 (J5), the best performance can be achieved by executing [KGC-1 SETTING],

- 1** Press the [MENU] key.
- 2** Move to the system menu.
 Refer to 3.1 Display of System Menu.
- 3** Select [NMEA] → [KGC-1 SETTING], and press the [▶] key.
- 4** Press the [ENT] key.
- 5** Select [Yes] with the [▲] and [▼] keys.
- 6** Press the [ENT] key.

Both the Display unit and the KGC-1/KGC-222 are properly set.
The HDT, GGA and VTG signals are outputted from the KGC-1/KGC-222, and baud rate is set to 38,400.

3.5 Preset

In the Preset of the system menu, the radar is customized.

NAV Display Select

When [DISPLAY SELECT] is set to [PPI/NAV], set the content to be displayed on the NAV display.

Language Select

Select the language used in the menu.

[F1]-[F6] Key Set

Select the function assigned to F1-F6 keys.

Select Range S/M/L

Select the range to be set with the [- RANGE +] key.

Echo Color Set

Set an arbitrary color to the video color.

Trail Color Set

Set an arbitrary color to the trail color.

Display Color Set

Set an arbitrary color to the color of cursor and numerals.

Camera Position Correction

The CCD camera video displayed by pressing the [STC/FTC] knob may be shifted.
By performing [CAMERA POSITION], the display position of CCD camera video can be corrected in the upper and lower directions.

3.6 Maintenance

The self-diagnosis of the system menu is the menu for maintenance. Normally, it is not used.
Perform the self-diagnosis of the Display unit and the antenna.

Processor Unit

The state of the Processor unit is displayed.
The version of the system program is displayed.

Antenna

The state of the antenna is displayed.
The type of antenna connected and the state of voltage are displayed.

Panel Test

Testing the operation block is performed.

LCD Test

Testing the display is performed.

Operation Hours Reset

The memorized operating hours are reset.

TX Hours Reset

The memorized transmitting time is reset.

All Reset

The internal memory is reset.
All of the set values are returned to the
factory-settings.

System Program Renewal

The system program is renewed from the
external equipment.

Chapter 4 Maintenance

4.1 Maintenance

To operate the radar equipment in a good condition for a long period of time, perform the inspection and cleaning periodically.

4.1.1 Monthly Inspection

 Caution: Before starting the inspection, ensure to turn off the power of the radar equipment.

 Do not turn on the power of the radar during inspection.

- (1) To protect the LCD and enhance the visibility, the acrylic filter is installed on the surface. If the acrylic filter is dirty, an image cannot be clearly seen. If dirty, dip a soft cloth into a neutral detergent, wring it lightly and wipe the filter surface lightly with the cloth. Do not use a dry cloth. If done so, due to static electricity, the acrylic filter will attract dust.

 Caution Never use a thinner solvent. The filter surface will be chemically decomposed, resulting in the loss of the transparency.

- (2) Check that the radiation surface of the antenna is not dirtied by soot. Dip a soft cloth into water or soap water, wring lightly and wipe the antenna with the cloth. Check for damage and paint sticking.

Note: Before performing the maintenance and inspection of the antenna, thread a string through the hole of radome (upper) as illustrated below and hang it up.

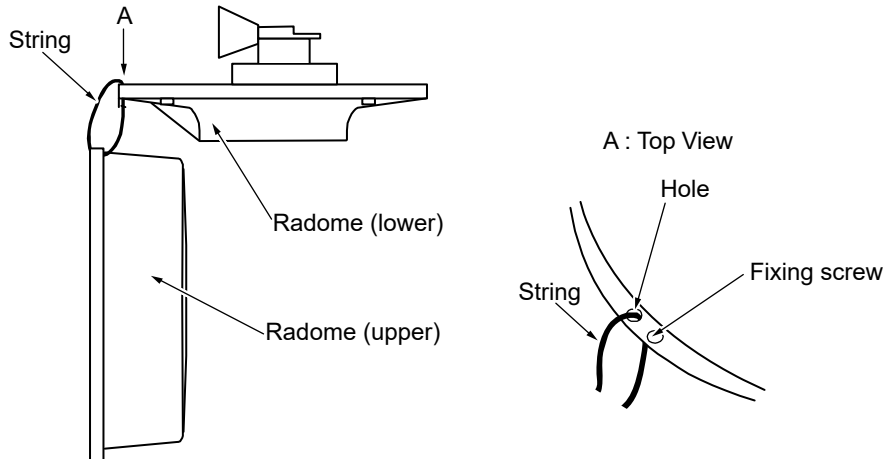

4.1.2 Yearly Inspection

In case of Open antenna (RB806/RB807/RB717A/RB718A), check the brush of the antenna drive motor inspect every 2,000 hours of transmission. If the length is shorter than 6mm, replace it with a new one.

Press the [MENU] key and select [MAINTE] → [PROCESSOR UNIT], message of transmission time is displayed.

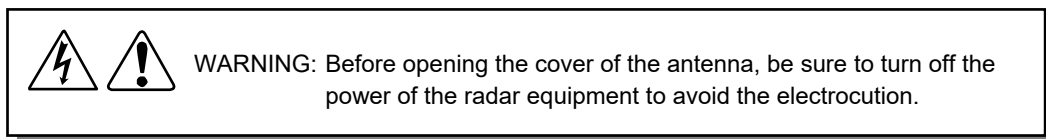
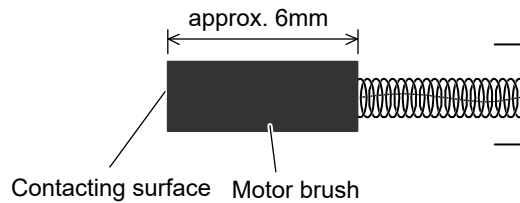

- (1) Loosen the fixing screws and remove the cover of the antenna at the bow side. The antenna drive motor can be seen at the lower side in the cabinet.
- (2) Referring to the illustration below, remove the motor brush with flat screw driver.
- (3) Insert the screw driver in the groove of the brush and rotate it counterclockwise and slowly. Be sure to replace both brushes at both sides.
- (4) Insert new brushes and install the brushes in reverse steps.

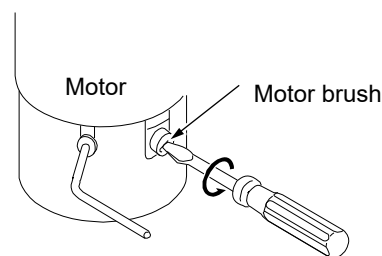
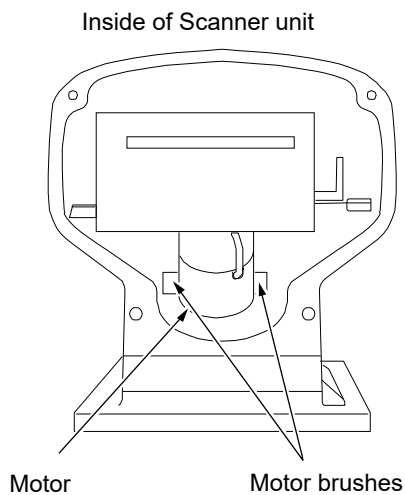

To remove the motor brush, turn it counterclockwise and slowly with the screwdriver.

4.2 Fuse Replacement

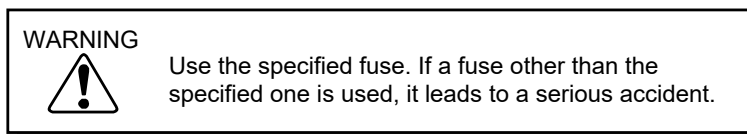

If the input voltage is too high, hyper-current flows or a trouble occurs inside, the fuse blows out. The fuse is housed in the rear side of the Display unit.

4.3 Consumables

This unit employs the magnetron which is the consumables and needs the replacement periodically. The magnetron is housed in the Scanner unit. When it is hard to see an image at a far distance, the magnetron may be deteriorated. In this case, replace the magnetron. When replacing, consult your sales dealer.

Press the [MENU] key and select [MAINTE] → [PROCESSOR UNIT], message of transmission time is displayed.

Replacement target: Normally 3,000 hours

4.4 Trouble Diagnosis

In this chapter, for finding a troubled location on a ship, a simple troubleshooting is mentioned.

4.4.1 Information required for requesting a repair

Inform us of the following items.

- (1) Name of ship, telephone number if the satellite communication system is equipped
- (2) Type of equipment
- (3) Manufacturing number of the equipment
- (4) ROM version (Press the [MENU] key and select [MAINTE] → [PROCESSOR UNIT], message of ROM version is displayed.)
- (5) Port of next arrival, arrival schedule and dealer name
- (6) Trouble situation and inspected result on a ship

4.4.2 Error Display

When a trouble occurs in the equipment or by miss-operation, the content of the troubles are displayed on the radar screen. The error, alarm and warning are provided at the time of troubles. When a trouble is confirmed in the radar, after recording the trouble classification, abnormal location and abnormal content, press the [ENT] key. And then alarm and error display will disappear.

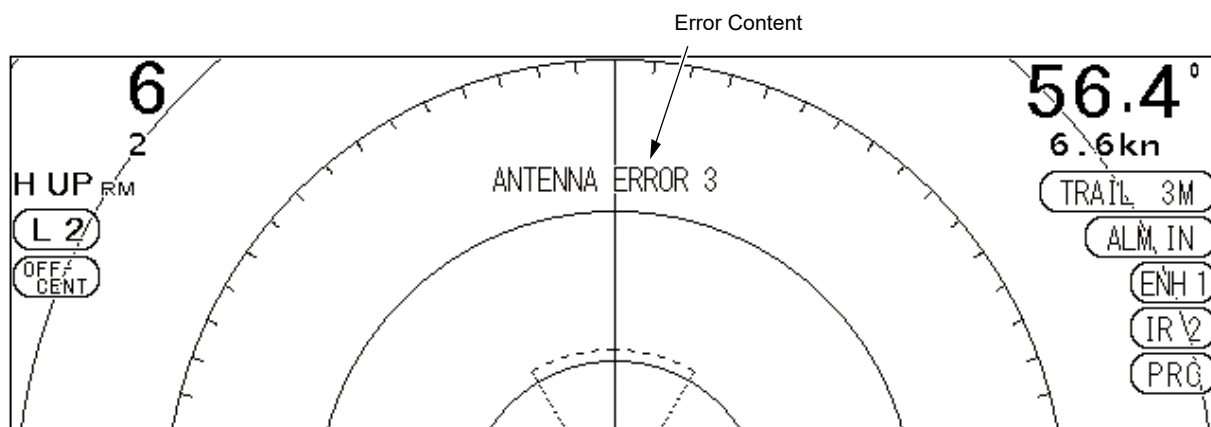

Error Display	Causes
L/L NO SIGNAL	The latitude and longitude is not entered.
HDG NO SIGNAL	The bearing signal is not entered.
SPD NO SIGNAL	The ship speed signal is not inputted.
ANTENNA ERROR 1	The trigger signal is not inputted from the antenna.
ANTENNA ERROR 2	The video signal is not inputted from the antenna.
ANTENNA ERROR 3	The heading signal is not inputted from the antenna.
ANTENNA ERROR 4	The auto tune is abnormal.
ANTENNA ERROR 5	The transmission voltage (+250V) is abnormal.
ANTENNA ERROR 6	The magnetron current is abnormal.
ANTENNA ERROR 7	The heater voltage of the magnetron is abnormal.

4.4.3 Self-diagnostic Function

The self-diagnostic menu is provided in the equipment.

Referring to 3.6 Maintenance, check for the abnormality of the radar.

4.4.4 Inspection at Each Location

After finishing the inspection by the self-diagnosis, according to the table, check each location of the radar.

Trouble conditions	Suspected causes of troubles	Countermeasures
The radar cannot be powered.	The power cable is not connected.	Connect the power cable and fix the connector firmly.
	The power voltage is out of the specified range.	Use the appropriate power.
	The main power fuse blew out.	Replace the fuse with a new one.
The radar can be powered. But, nothing is displayed on the screen.	The screen brightness adjustment is set to the minimal value.	Adjust the brightness with the [BRILL] key.
	The monitor cable is not connected.	Connect the monitor cable and fix the connector firmly.
	Defect of the LCD drive circuit	Request the repair.
The character information can be displayed. But, the image of the radar cannot be displayed.	The mutual connection cable is not connected.	Connect correctly the mutual connection cable.
	Detuned.	Re-adjust. ☞ Refer to Tune Select in 3.3 setting of Adjustment Items.
	Defect of the transmission equipment	Request the repair.
The target image is different from the actual one.	The heading is not correctly set.	Set the heading. ☞ Refer to Bearing Setting in 3.3 Setting of Adjustment Items.
	The distance adjustment is not properly set.	Set correctly the TX delay adjustment. ☞ Refer to TX Delay in 3.3 Setting of Adjustment Items.
The image is weak.	The set value of the gain is low.	Rotate clockwise the [GAIN/PPI] knob to display an image.
	The setting defect of STC or FTC.	Re-adjust. ☞ Refer to 1.8 STC Adjustment or 1.9 FTC Adjustment.
	Detuned.	Re-adjust. ☞ Refer to Tune Select in 3.3 Setting of Adjustment Items.
	Defect of the magnetron or MIC (front end)	Request the repair.
Too much noise	Detuned.	Re-adjust. ☞ Refer to Tune Select in 3.3 Setting of Adjustment Items.
	The radar is not grounded.	Connect the ground wire.
The antenna does not rotate.	The power is not fed to the motor.	Check the connection of the motor power.
	The motor brush is worn.	Replace the motor brush with a new one.

Chapter 5 Equipment

5.1 Antenna Installation

Determining the location of the installation

The search capability of the radar varies largely, depending on the position of the antenna installation. The ideal installation position is the high place over the keel line where no obstacle surrounds. Actually, though there are many limitations in a ship, determine the installation position, considering the following items.

1. The antenna block should be over the line drawn between the bow and the stern, and should be installed to a position where no obstacle to block the radiation path of the radar beam is present.
2. To avoid the electromagnetic wave interference with human bodies, install the antenna block higher than the living space by 0.6m. However, if installed at the higher position, objects at the near distance cannot be searched. Thus, when approaching to a pier, if the radar is used, you must pay attention.
The higher the position of the antenna is, the stronger the reflection from the sea surface becomes.
3. Keep the surface of the platform, where the antenna is installed, horizontal as possible to be parallel with the sea surface.
4. Install the antenna lock in front of the large structure and exhaust chimney to avoid the blind sector (inability angle of image search) on the screen and to prevent the opening of the antenna from being dirtied by the engine exhaust.
5. Keep enough space for maintenance.
6. To prevent a blind or ghost from occurring in the heading, place the antenna towards the bow rather than obstacles, keep it away from obstacles. And when installing the antenna on the mast, place it in front of the mast. (If obstacles cannot be avoided due to limitation of structure, refer to [How to shift the antenna from an obstacle] described later.
7. Keep away the antenna from other equipment's antenna.
Keep a distance from antennas of a direction finder and a VHF transmitter-receiver as far as possible.
8. Keep a distance for safety from the magnetic compass.

Safety Distance from Magnetic Compass

Type of Scanner	Standard Compass	Steering Compass
RB804	2.0m	1.4m
RB805	2.0m	1.4m
RB806	2.0m	1.4m
RB807	1.2m	0.8m
RB808	1.4m	0.9m
RB717A	1.4m	0.95m
RB718A	1.4m	0.95m

WARNING



Install the antenna, keeping it away from wireless equipment not to be interfered.

How to shift the antenna from an obstacle

1. How to shift the antenna from the keel line

By shifting the antenna from keel line to the starboard, the blind moves to the port and the visibility in the heading can be secured. According to a distance to an obstacle, the distance to be shifted can be derived from the formula below.

$L_s = 0.4R + D/2$ [m] ($R < 15$ m)
 $L_s = 0.025R + D/2$ [m] ($R \geq 15$ m)
 L_s : Distance to be shifted from the keel line
 D : Diameter of an obstacle over the keel line
 R : Distance to an obstacle

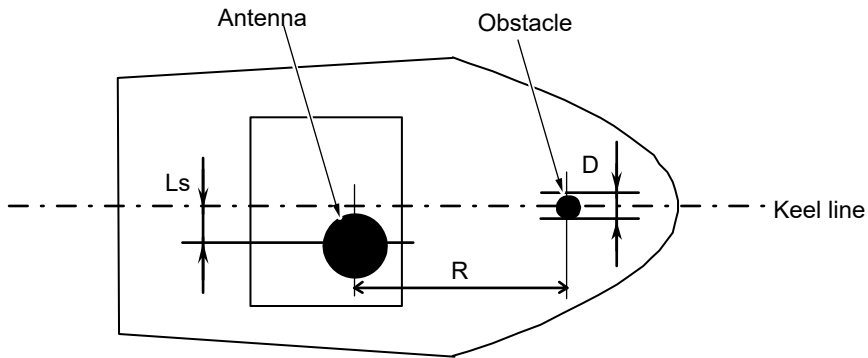

How to shift the antenna from the keel line

2. How to keep an angle of depression

To keep enough angle of depression θ that is an angle between the horizontal and the observer's line of sight (In this case, it is not the observer but an antenna), elevate the antenna height. By making θ more than 5° , the blind at the middle and long distances can be avoided. An object below the line of sight cannot be detected.

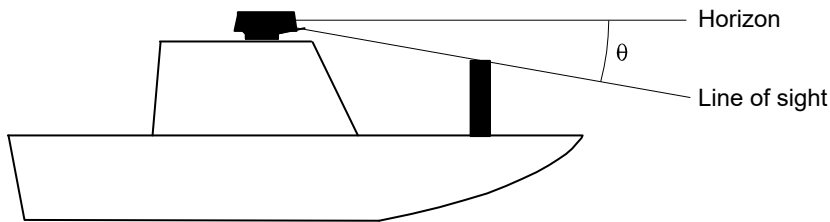

How to keep an angle of depression

Installation of Antenna

After determining the location of the installation, install the antenna. When installing, if the bracket shown below is available, the installation is easier. If not available, install the antenna directly on the roof, paying attention to the air tube for drain at the bottom of the antenna.

Note: If the radar mast or installation bracket is warped more than 2mm, make it flat or adjust by inserting spacers.

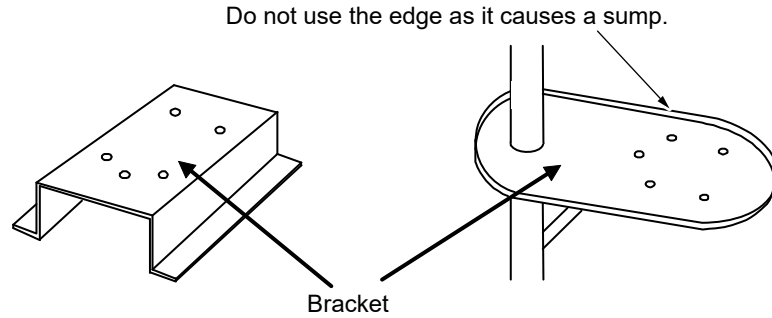

Installation of Radome Antenna

Referring to the illustration below, make five (5) holes on the cradle and fix the bracket and the antenna together with hexagon bolts. If the thickness of the bracket is 9 to 14mm, it can be installed with the supplied bolts. If not within this range, prepare bolts shown on the table in the next page. To prevent the looseness from occurring, fortify with the commercially available loose-preventive silicon sealing. However, for preventing the looseness of the radome antenna, do not use the putty. The putty may deteriorate chemically the plastic material of the radome.

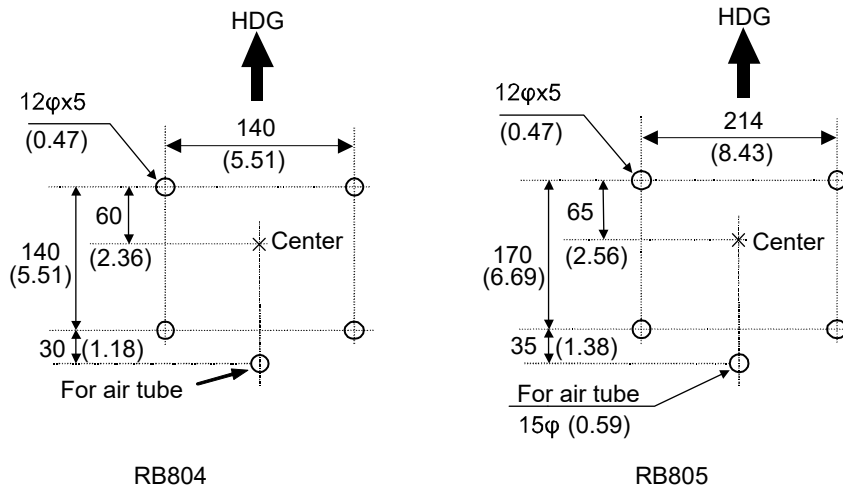

Unit: mm (inch)

Drawing of Work for Installation Holes on the Bracket

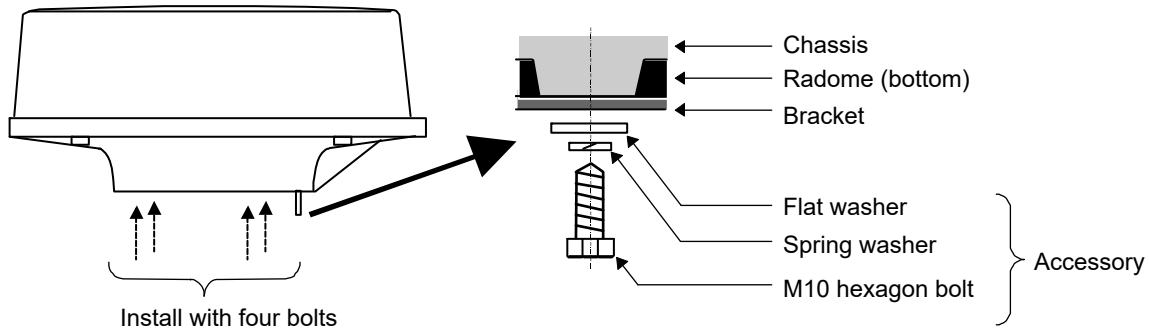

Specification of bracket thickness-wise installation bolt (In case of RB804)

Thickness of bracket	Bolt for fixing the antenna	Material	Remarks
4 to 11 mm (0.16 to 0.44 in)	M10x40 (pitch 1.5mm)	stainless	Included in accessories
11 to 19mm (0.44 to 0.75 in)	M10x45 (pitch 1.5mm)	stainless	

Specification of bracket thickness-wise installation bolt (In case of RB805)

Thickness of bracket	Bolt for fixing the antenna	Material	Remarks
4 to 9 mm (0.16 to 0.35 in)	M10x20 (pitch 1.5mm)	stainless	
9 to 14mm (0.35 to 0.55 in)	M10x25 (pitch 1.5mm)	stainless	Included in accessories
14 to 19 mm (0.55 to 0.75in)	M10x30 (pitch 1.5mm)	stainless	

Setting of Open Antenna

As illustrated below, install the Scanner unit, facing the cut portion of the installation base toward the stern. This makes it easier to perform the maintenance

1. Referring to the illustration below, make holes of 14mm diameter on the installation side of platform.
2. Place the Scanner unit at the specified position and fix it with four 12mm stainless bolts included in the installation material. If the thickness of the bracket is 9 to 14mm, the bracket can be installed with the supplied bolts. If not within this range, prepare the bolts shown on the table in the next page.

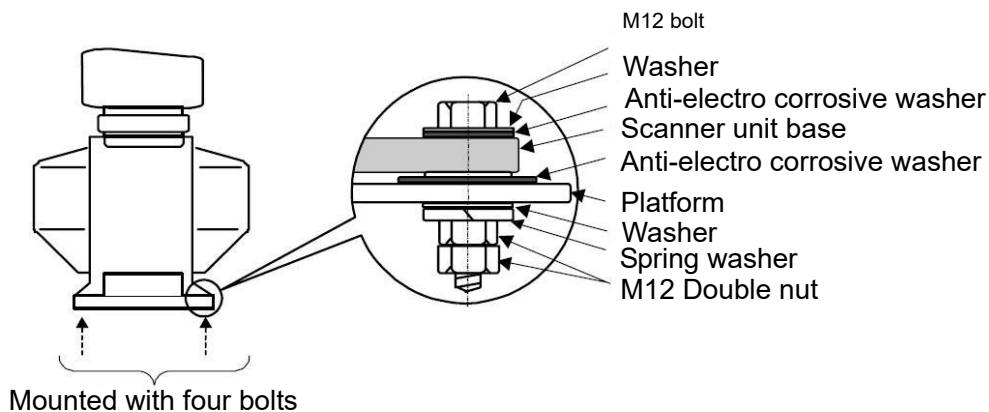
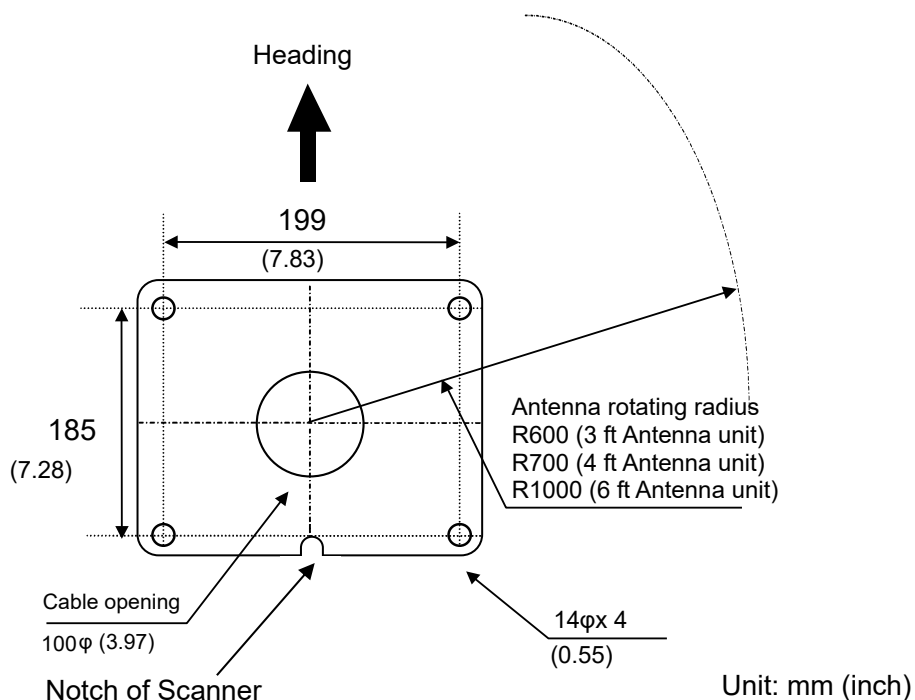

Specification of bracket thickness-wise installation bolt (In case of Open Antenna)

Thickness of bracket	Bolt for fixing the antenna	Material	Remarks
4 to 9 mm (0.16 to 0.35 in)	M12x50 (pitch 1.5mm)	stainless	
9 to 14mm (0.35 to 0.55 in)	M12x55 (pitch 1.5mm)	stainless	Included in accessories
14 to 19 mm (0.55 to 0.75in)	M12x60 (pitch 1.5mm)	stainless	

Installation of Antenna

1. Remove the protective cap covered on the output of the Scanner unit rotational shaft.
2. Remove four bolts tentatively fixed to the base of the Antenna and install the Scanner unit to the rotating base. Match the direction of antenna radiation side (KODEN –mark side) with the projection mark on the rotating base.
3. Fix the aerial with four bolts removed in step 2.

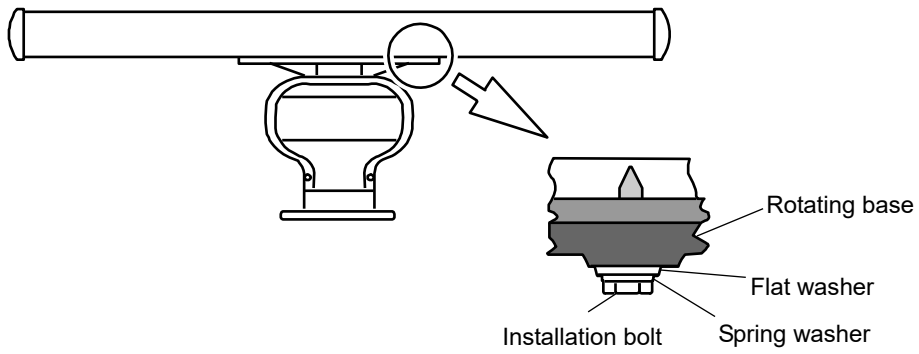
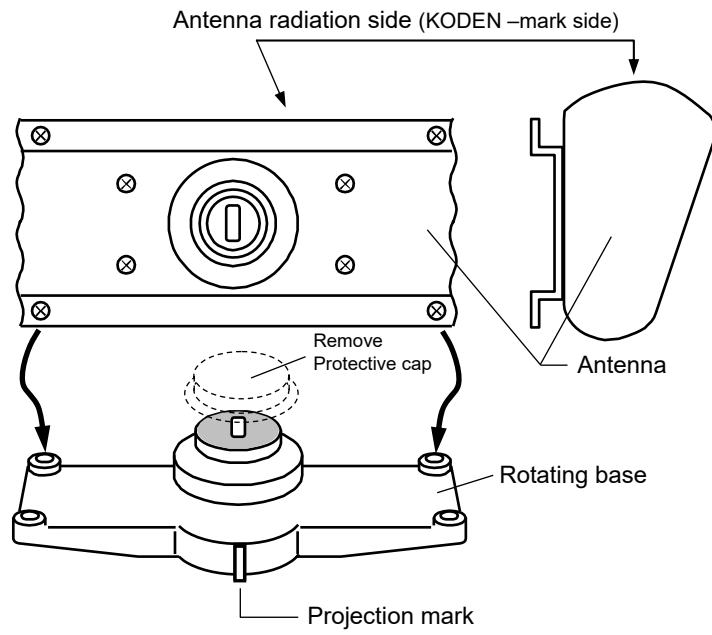

Cable Connection

Radome Antenna 4kW (RB804/RB805)

1. Confirm that the power of the Radar unit is turned off.
Remove the upper radome of the Scanner unit, lifting upward not to touch the aerial inside.
(4 pieces of fixing screw)
2. Peel off the tape fixing the aerial.
3. Remove the shield cover at the stern side. (RB804: 3 pieces of fixing screw / RB805: 4 pieces of fixing screw)
4. Remove the holder plate for fixing the cable and the rubber ring
Thread the cable through the leading opening
Insert the rubber ring from both sides of the Scanner unit, thread it through the holder plate and fix it to the aerial with the screws.
5. Connect the 7-pin connector of the cable to X11 of the printed circuit board and the 9-pin connector to X12 respectively.
6. Install the shield cover. At this moment, install the shield of the cable in the groove, using the shield cover. But, be careful for the cable not to be caught by the unit and the cover.
7. Install the upper radome with caution not to touch the aerial. Orient the cover as shown in the illustration below. The screw positions are marked on the upper and lower radomes respectively. (RB804: 3 marks, RB805: 4 marks) Install the radome, aligning these markings.
8. Install the antenna cable to the connector J7 at the rear of the Display unit. (Refer to page 5-13)

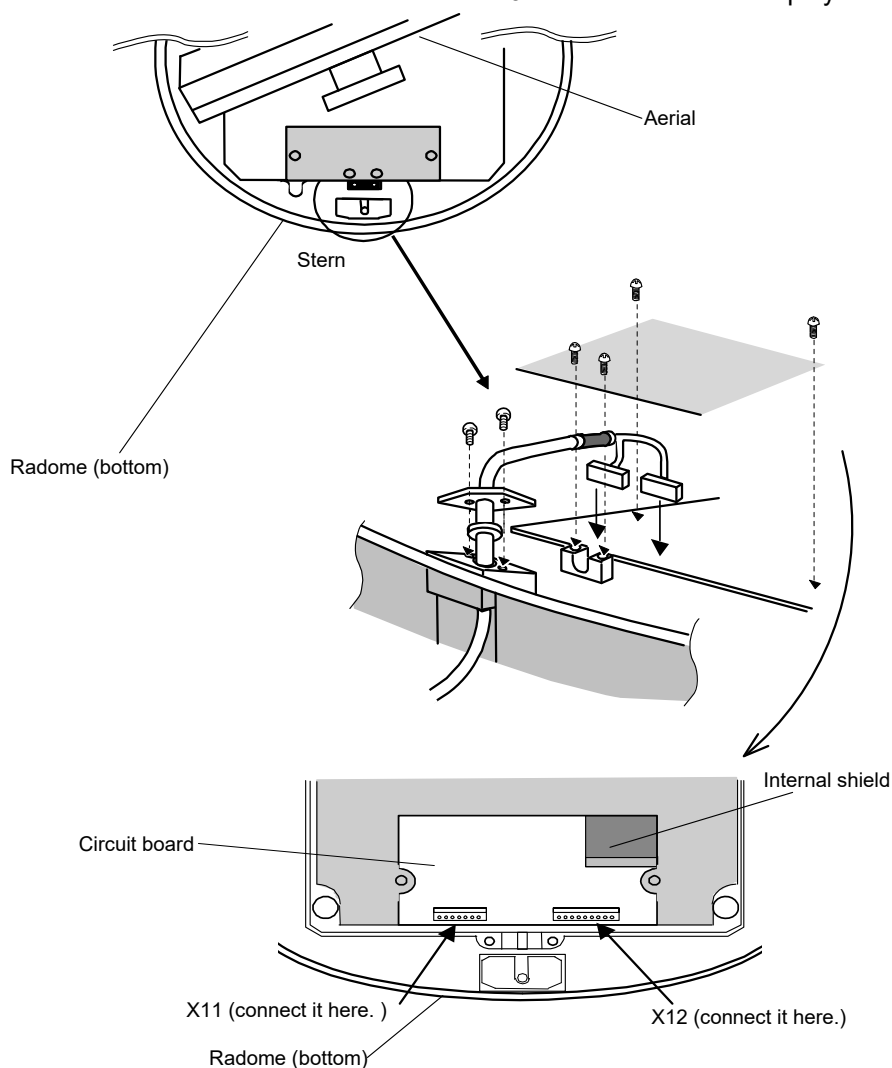

Installation of 4kW radome antenna cable

Open Antenna 4kW (RB806)

1. Please make sure power supply of the Radar unit is OFF.
2. Disassemble the front cover of the Scanner unit from the rear cover by loosening fixing bolts.
3. Remove the TR unit by disconnecting the connector X1 and X2 after loosening fixing bolts of the TR unit. Please make sure magnetron does NOT touch metals.
4. Remove the cable holder plate and the rubber packing by loosening bolts at the bottom of the Scanner unit box.
5. Antenna cable shall be taken into the Scanner unit box through the cable inlet hole.
6. Antenna cable shall be fixed as described in the illustration below, using the cable holder plate and the rubber packing removed in 4. Shield braid terminal shall be fixed under the cable holder plate together with lug terminal, after removing the edge portion of heat contraction tube of the antenna cable.
7. Mount the TR unit after connecting the X1 and X2 connectors (removed in 3) by fixing bolts.
8. 7 pin connector shall be connected to X11 of the TR unit, 9 pin connector to X12.
9. Antenna cable shall be clamped onto the TR unit. Please make sure the antenna cable does NOT touch magnetron lead wires.
10. The front and rear covers of the Scanner unit shall be fixed by fixing bolts.

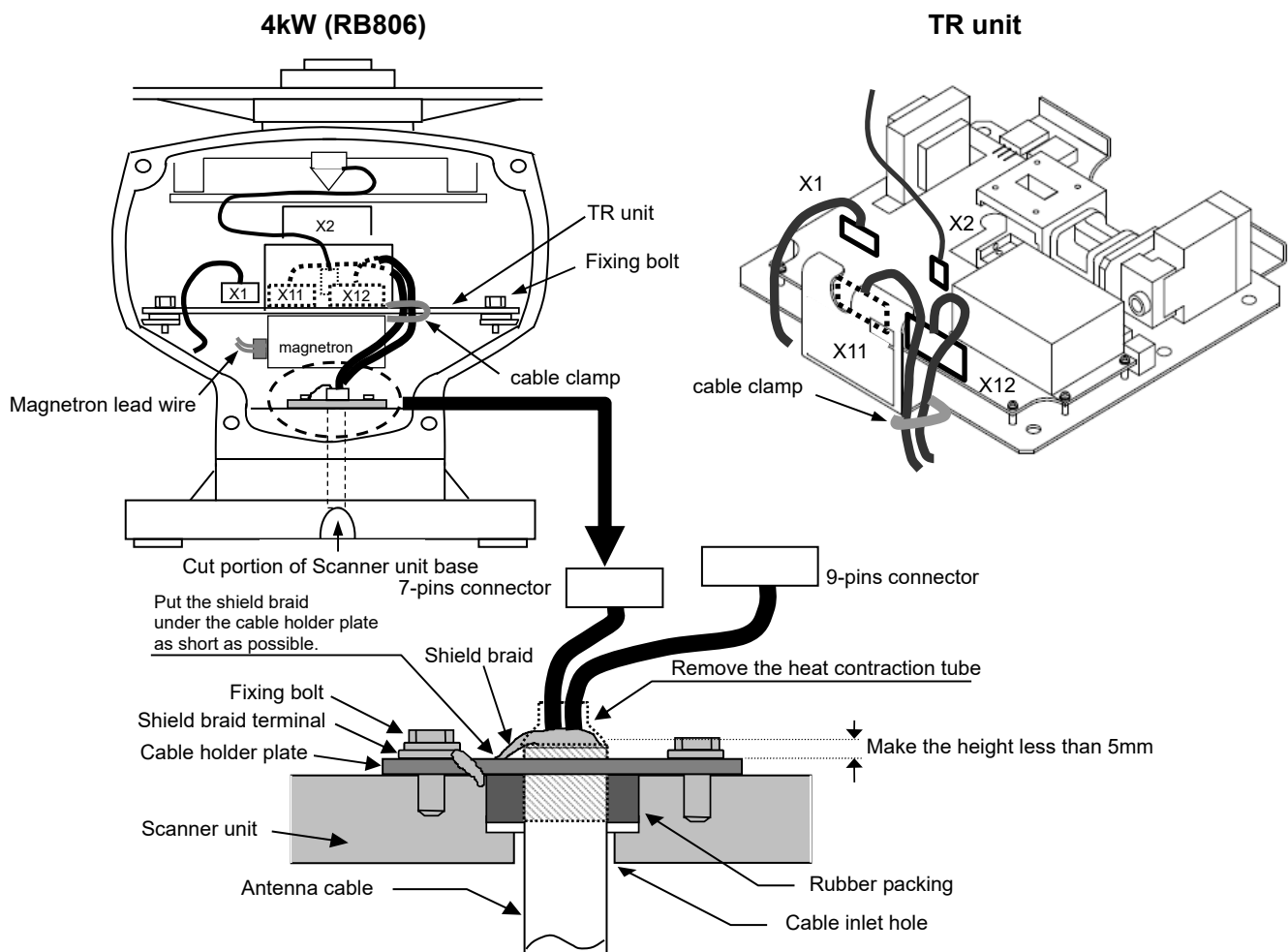

Open Antenna 6kW (RB807)

Make sure the radar system is turned off.



- 1) Remove back cover by loosening four fixing bolts.
(Tool: Wrench 13mm)

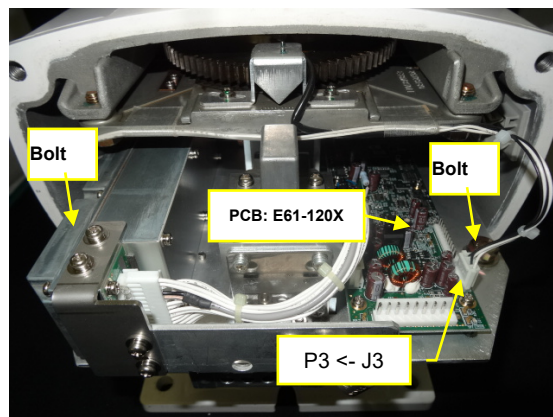

- 2) Disconnect connectors P3 from J3 [E61-120X].
Remove the two fixing bolts.
(Tool: Wrench 13mm)

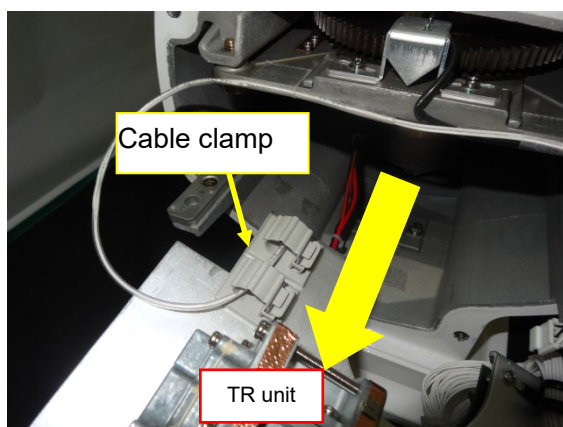

- 3) Pull out the TR unit, remove the cable clamp.

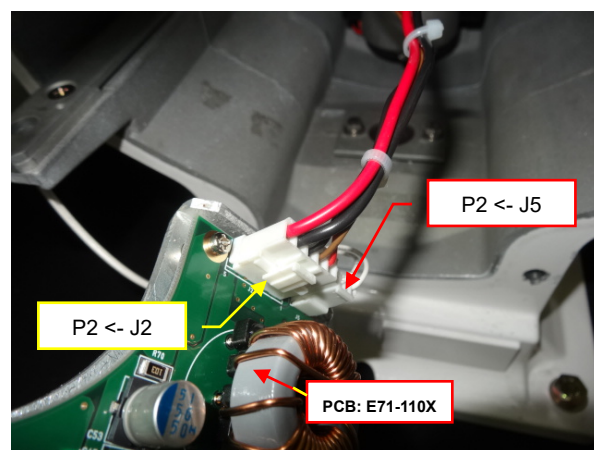

- 4) Disconnect connector P2 from J2 and P2 from J5.

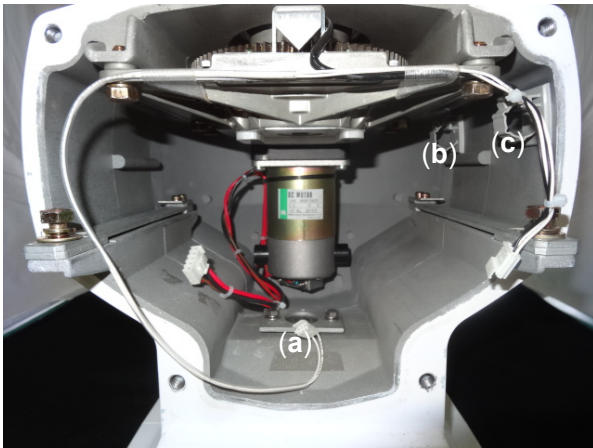

- 5) This picture is the view of scanner unit housing.
- (a) Cable holder plate
 - (b) Cable clamp-b
 - (c) Cable clamp-c

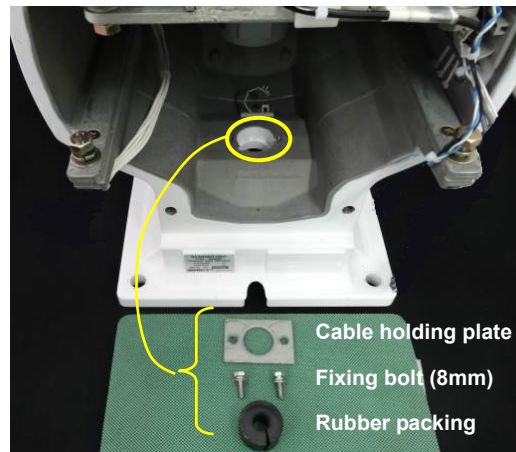

- 6) Remove two fixing bolts.
(Tool: Wrench 8mm)
- Remove the cable holding plate and rubber packing.

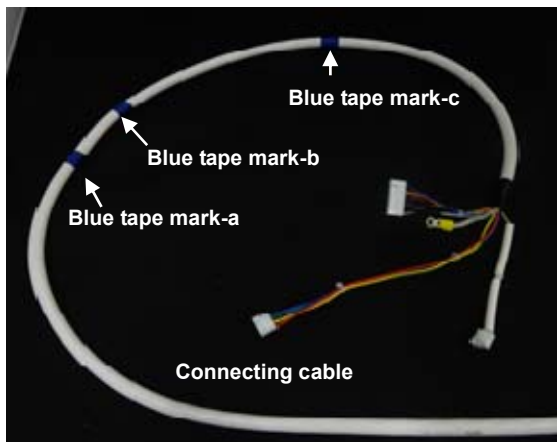

- 7) The connecting cable CW-845-xxM Blue tapes are wound as a mark on the cable.

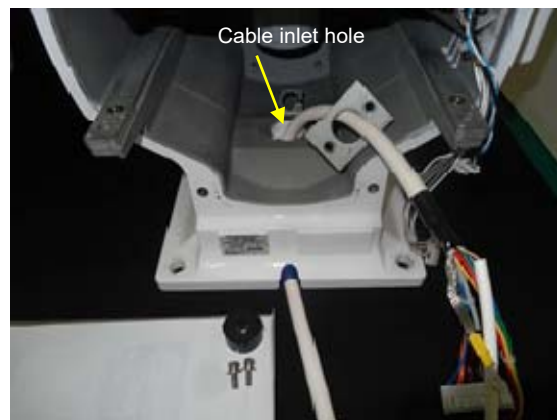

- 8) Pull in the connecting cable into the scanner unit through the cable inlet hole
- Guide the cable to the cable holding plate.

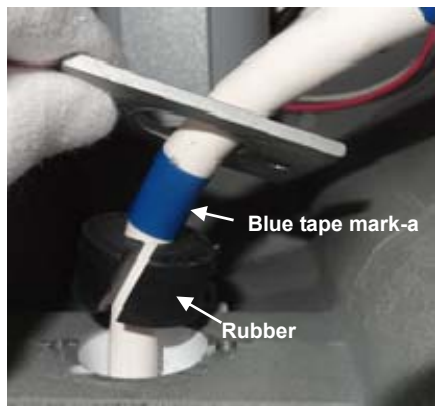

9) Attach rubber packing to the blue tape mark-a.



10) Attach cable holding plate and fix it with two bolts.
(Tool: Wrench 8mm)



11) Attach the ferrite core from blue tape-b to 10cm end.

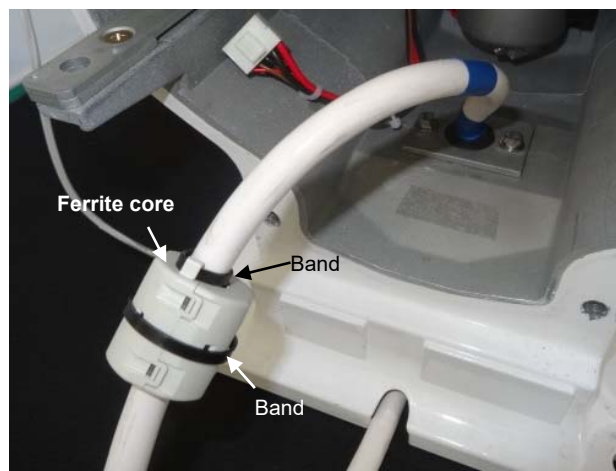

12) Secure the ferrite core in place by using provided bands.

Note: The ferrite core and the bands are included with the installation material.

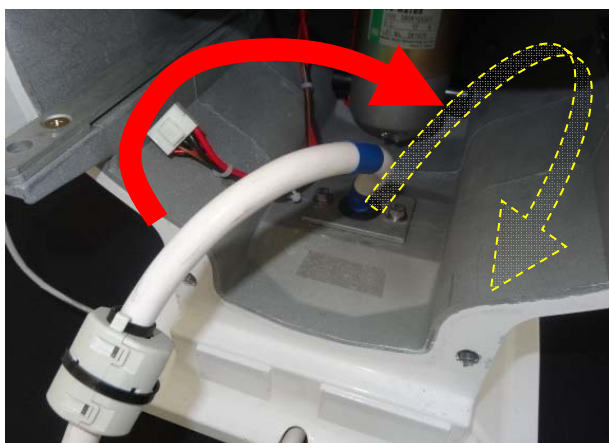

13) The cable placed in the far right under the motor.

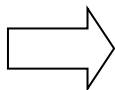

14) Clamp the cable by the cable clamp-b.

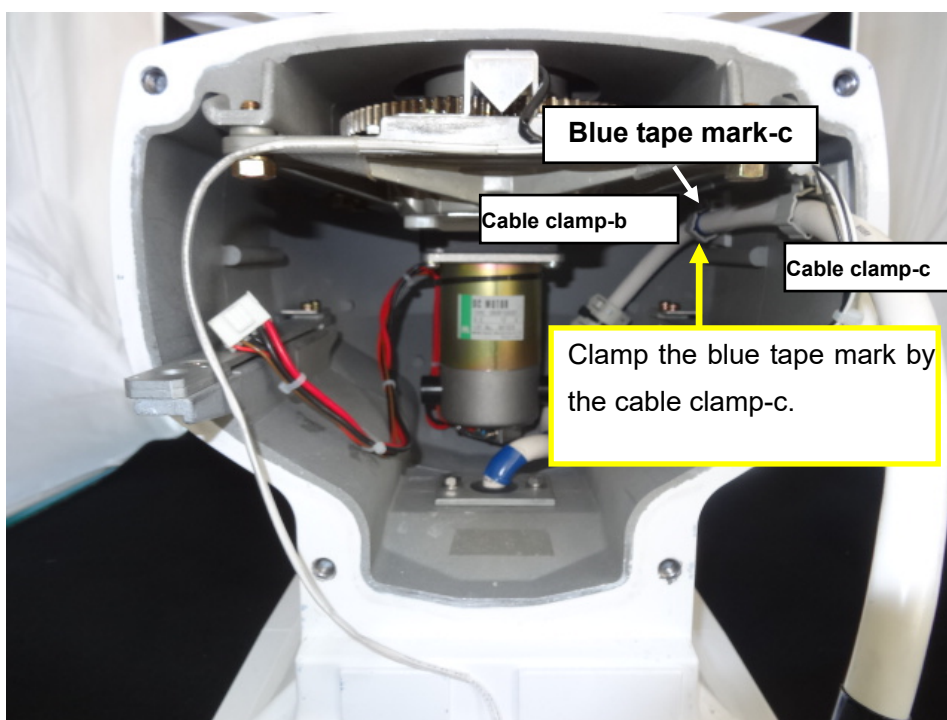

15) This picture is the view of the cable layout.
Clamp the blue tape mark-c by the cable clamp-c.

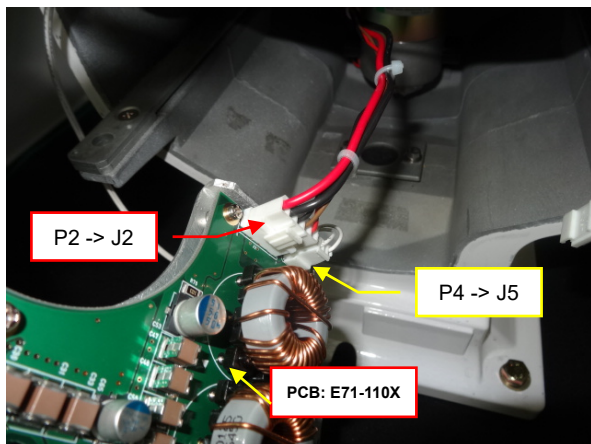

16) Connect connector P2 to J2 and P4 to J5. [PCB E71-110X].

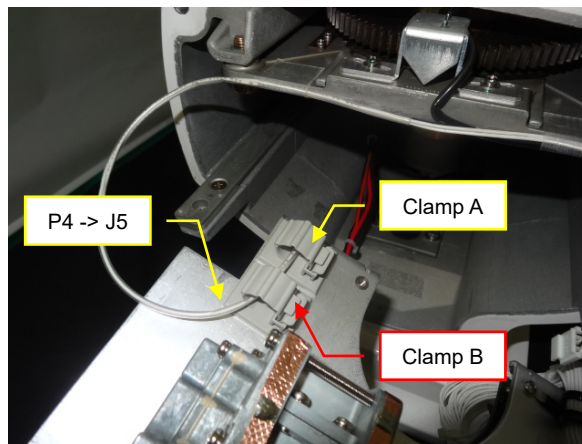

17) Through the P4 to J5 to clamp A and B.

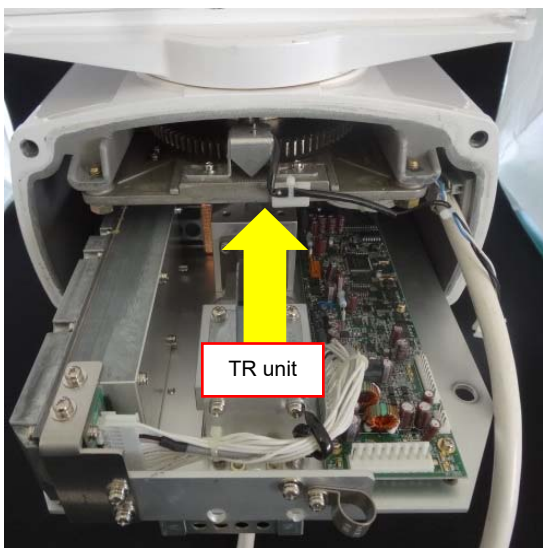

18) Insert TR unit in the scanner unit housing.

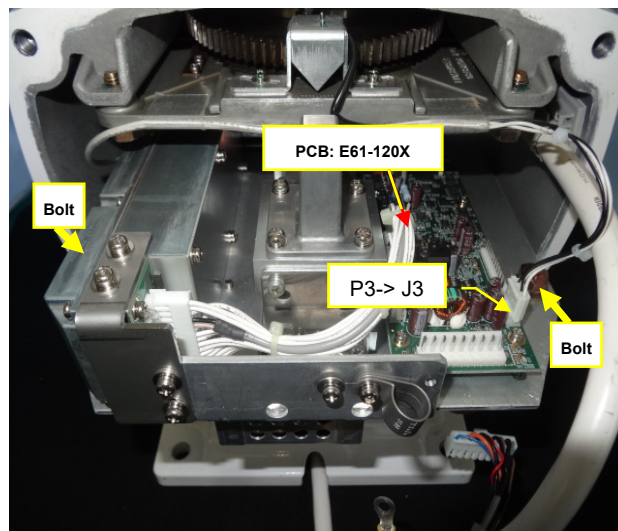

19) Connect connectors P3 to J3 [PCB E61-120X]

Fix the two fixing bolts.
(Tool: Wrench 13mm)

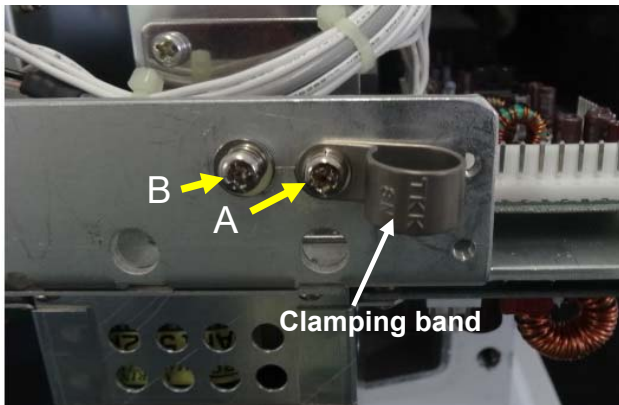

20) Remove the screw-A and the screw-B.

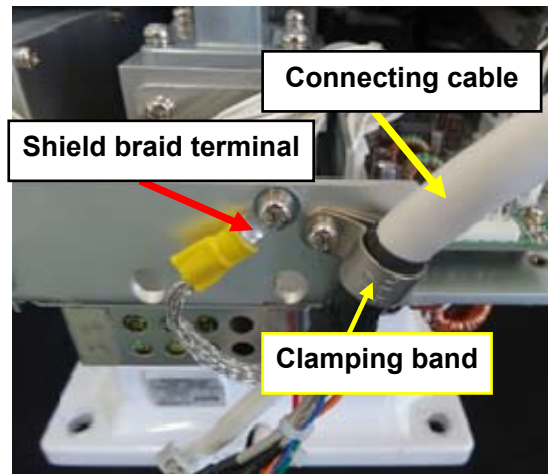

21) Clamp the connecting cable by the clamping band and fix with screw-A. Fix the shield braid terminal with screw-B.

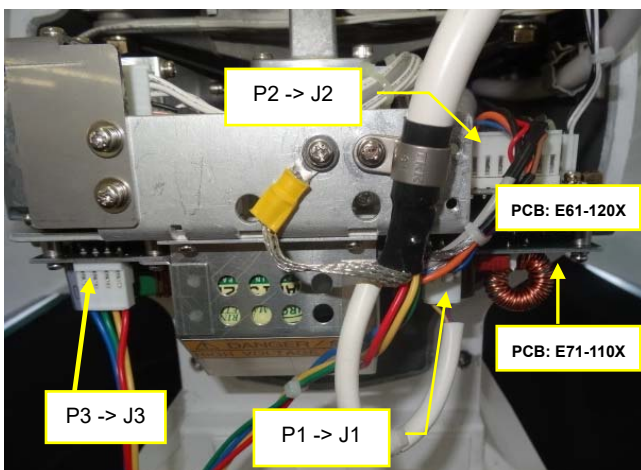

22) Connect connector P2 to J2 [PCB E61-120x]. Connect the connectors P1 and P3 to J1 and J3 [PCB E71-110X].



23) Attach the back cover by tightening four fixing bolts. (Tool: Wrench 13mm)

Open Antenna 12kW (RB808)

Make sure the radar system is turned off.



- 1) Remove back cover by loosening four fixing bolts.
(Tool: Wrench 13mm)

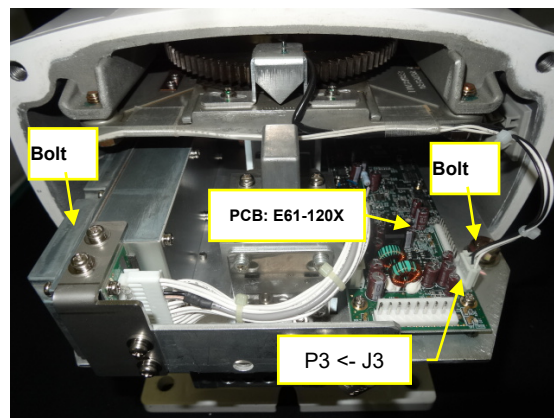

- 2) Disconnect connectors P3 from J3 [E61-120X].
Remove the two fixing bolts.
(Tool: Wrench 13mm)

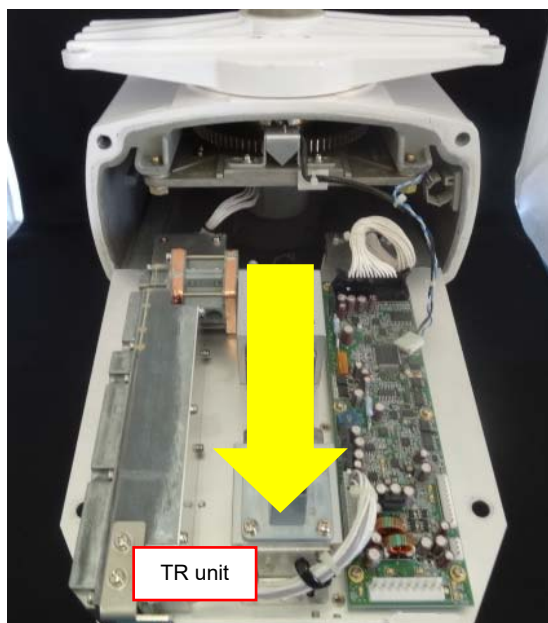

- 3) Pull out the TR unit.

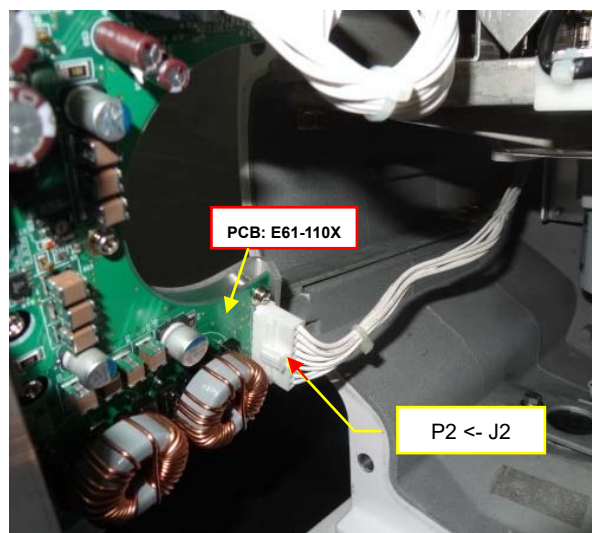

- 4) Disconnect connector P2 from J2 [E61-110X].

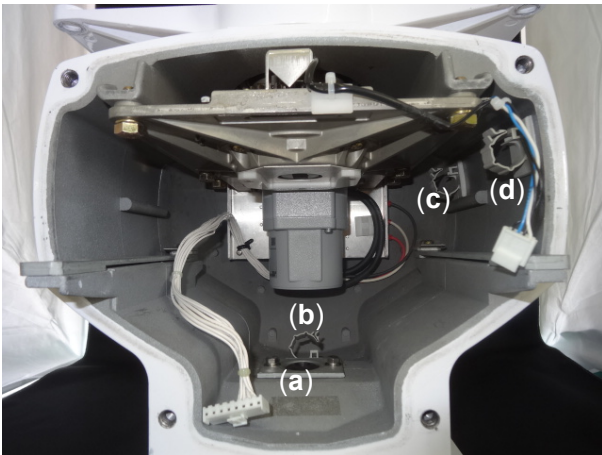

- 5) This picture is the view of the inside of the scanner unit housing.
- (a) Cable holding plate
 - (b) Cable clamp-b
 - (c) Cable clamp-c
 - (d) Cable clamp-d

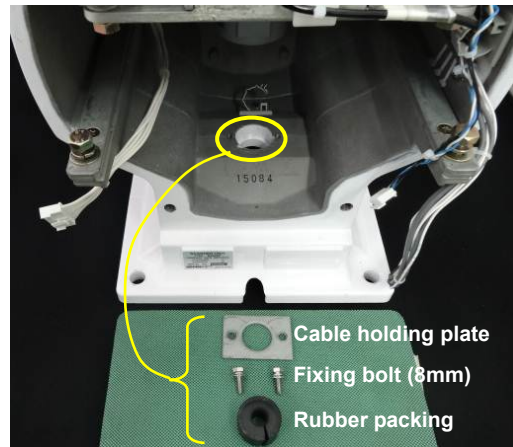

- 6) Remove two fixing bolts.
(Tool: Wrench 8mm)

Remove the cable holding plate and rubber packing.

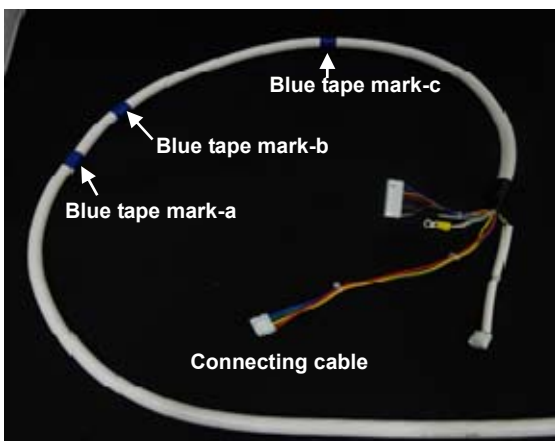

- 7) The connecting cable CW-845-xxM
Blue tapes are wound as a mark on the cable.

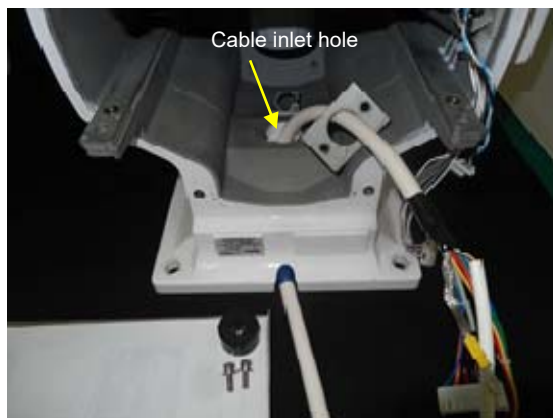

- 8) Pull in the connecting cable into the scanner unit through the cable inlet hole.
Guide the cable to the cable holding plate.



9) Attach rubber packing to the blue tape Mark-a.



10) Attach cable holding plate and fix it with two bolts.
(Tool: Wrench 8mm)

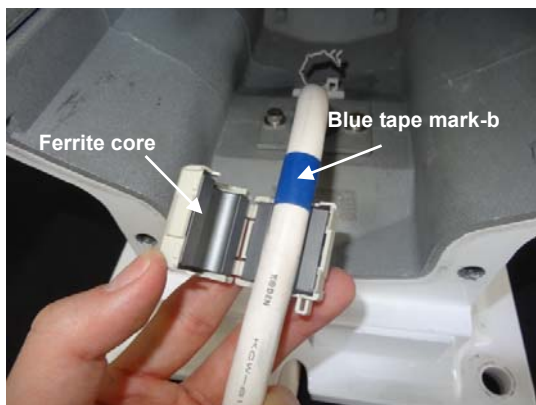

11) Attach the ferrite core to side of the blue tape mark-b.

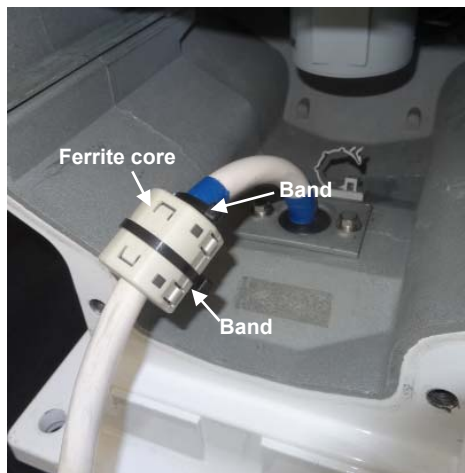

12) Secure the ferrite core in place by using provided bands.

Note: The ferrite core and the bands are included with the installation material.

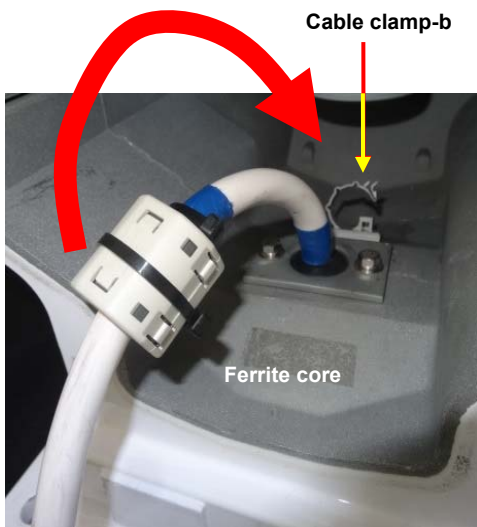

13) Tilt the cable with the ferrite core toward the cable clamp-b.



14) Clamp the cable by the cable clamp-b.

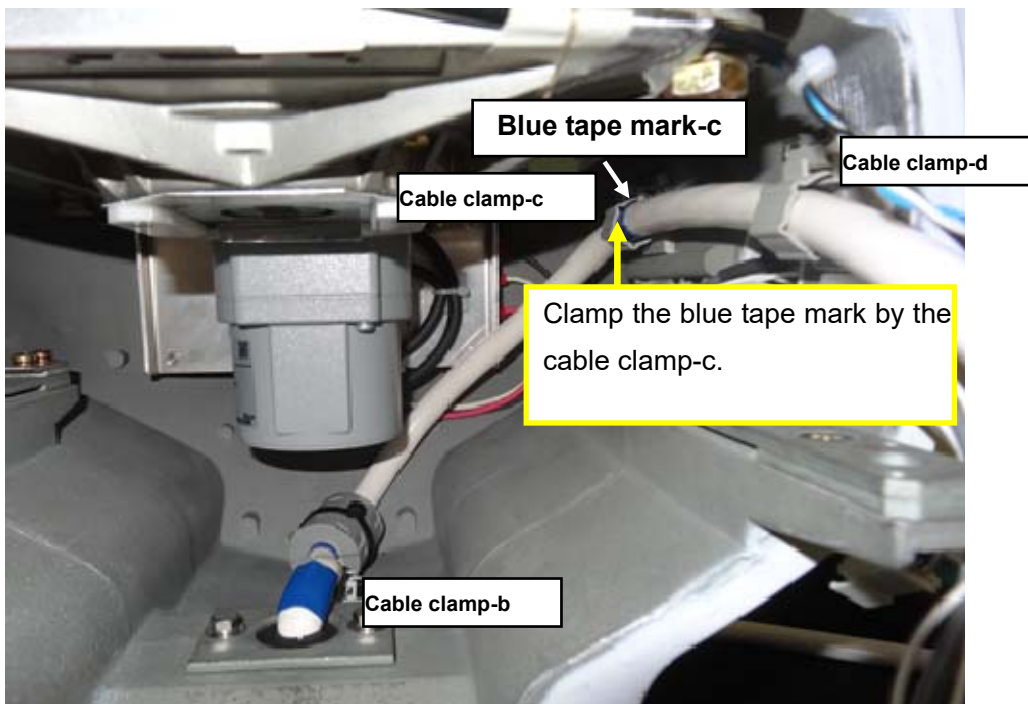

15) This picture is the view of the cable layout.
Clamp the blue tape mark-c by the cable clamp-c.

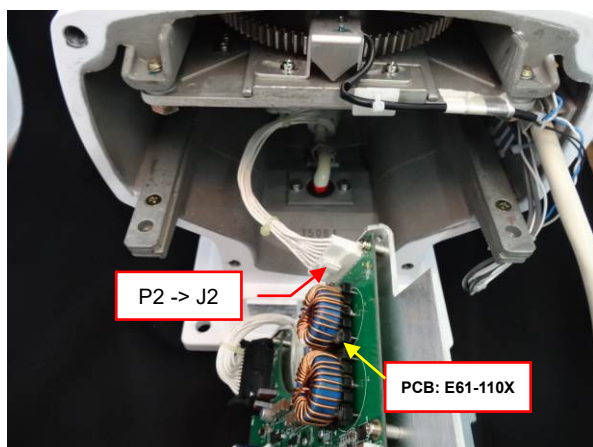

16) Connect connector P2 to J2 [PCB E61-110X].

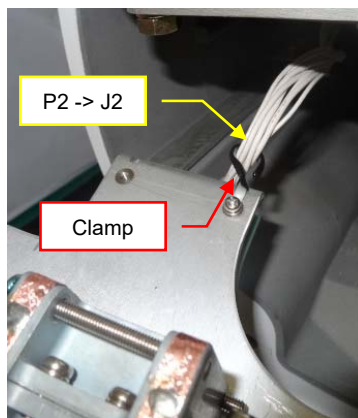

17) Hook the P2 to J2 to the clamp.

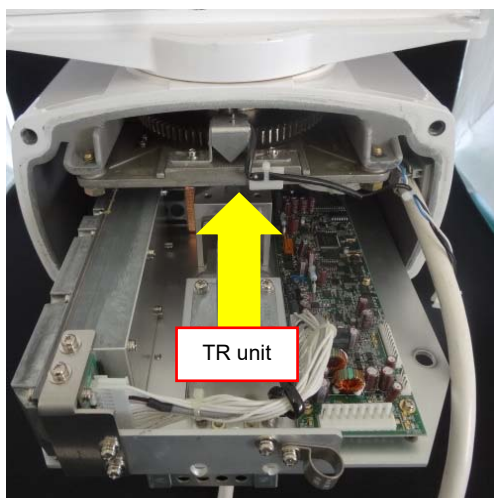

18) Insert TR unit in the scanner unit housing.

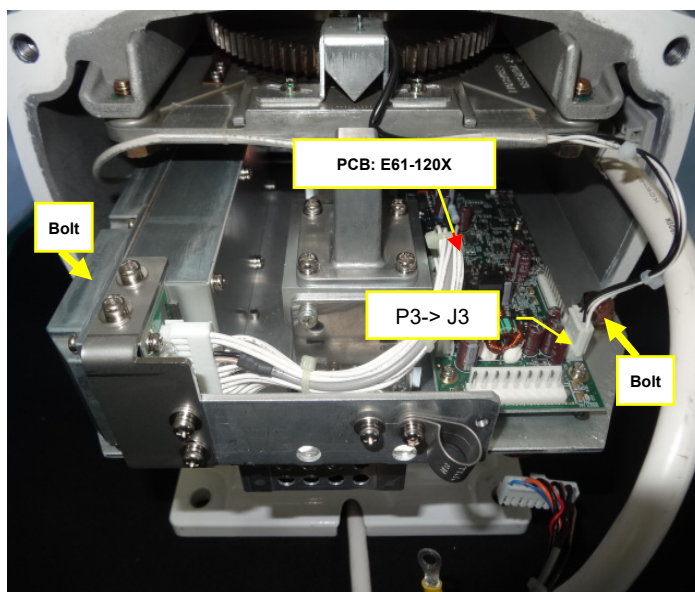

19) Connect connectors P3 to J3 [PCB E61-120X]

Fix the two fixing bolts.
(Tool: Wrench 13mm)

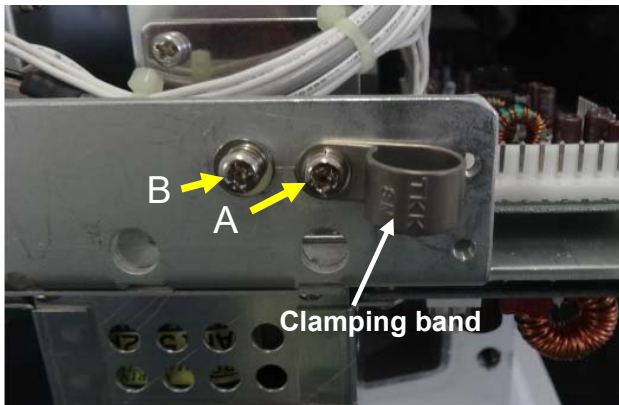

20) Remove the screw-A and the screw-B.

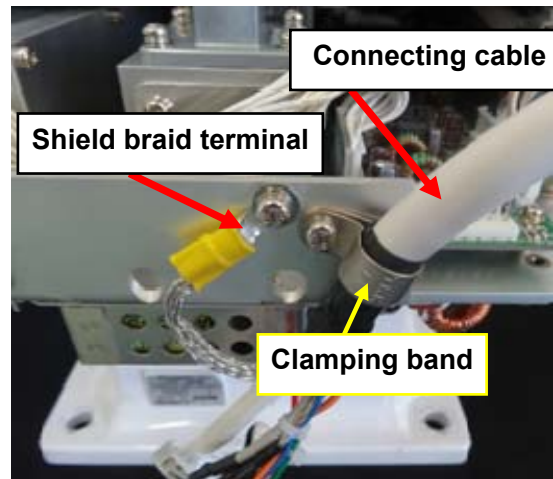

21) Clamp the connecting cable by the clamping band and fix with screw-A. Fix the shield braid terminal with screw-B.

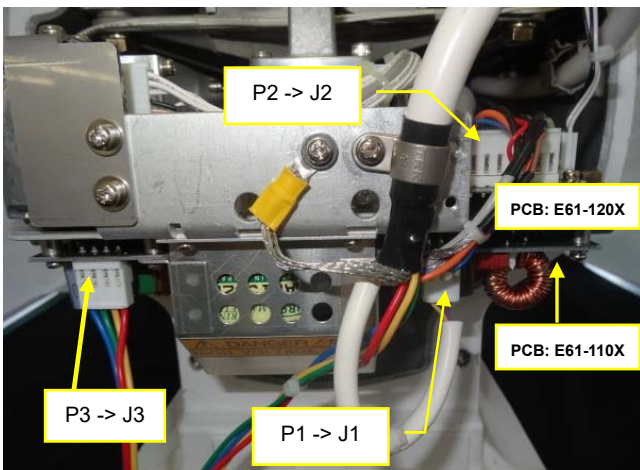

22) Connect connector P2 to J2 [PCB E61-120x]. Connect the connectors P1 and P3 to J1 and J3 [PCB E61-110X].



23) Attach the back cover by tightening four fixing bolts. (Tool: Wrench 13mm)

Open Antenna 6kW (RB717A), 12kW (RB718A)

1. Make sure power supply of the Scanner unit is OFF.
2. Disassemble the front cover of the Scanner unit from the rear cover by loosening fixing bolts.
3. Remove the TR unit by disconnecting the connector J3 and J4 after loosening fixing bolts of the TR unit. Please make sure magnetron does NOT touch metals.
4. Remove the cable holder plate and the rubber packing by loosening bolts at the bottom of the Scanner unit box.
5. Antenna cable shall be taken into the Scanner unit box through the cable inlet hole.
6. Antenna cable shall be fixed as described in the illustration below, using the cable holder plate and the rubber packing removed in 4. Shield braid terminal shall be fixed under the cable holder plate together with lug terminal, after removing the edge portion of heat contraction tube of the antenna cable.
7. Mount the TR unit after connecting the J3 and J4 connectors (removed in 3) by fixing bolts.
8. 7 pin connector shall be connected to J2 of the TR unit, 9 pin connector to J1.
9. Antenna cable shall be clamped onto the TR unit. Please make sure the antenna cable does NOT touch magnetron lead wires.
10. The front and rear covers of the Scanner unit shall be fixed by fixing bolts.

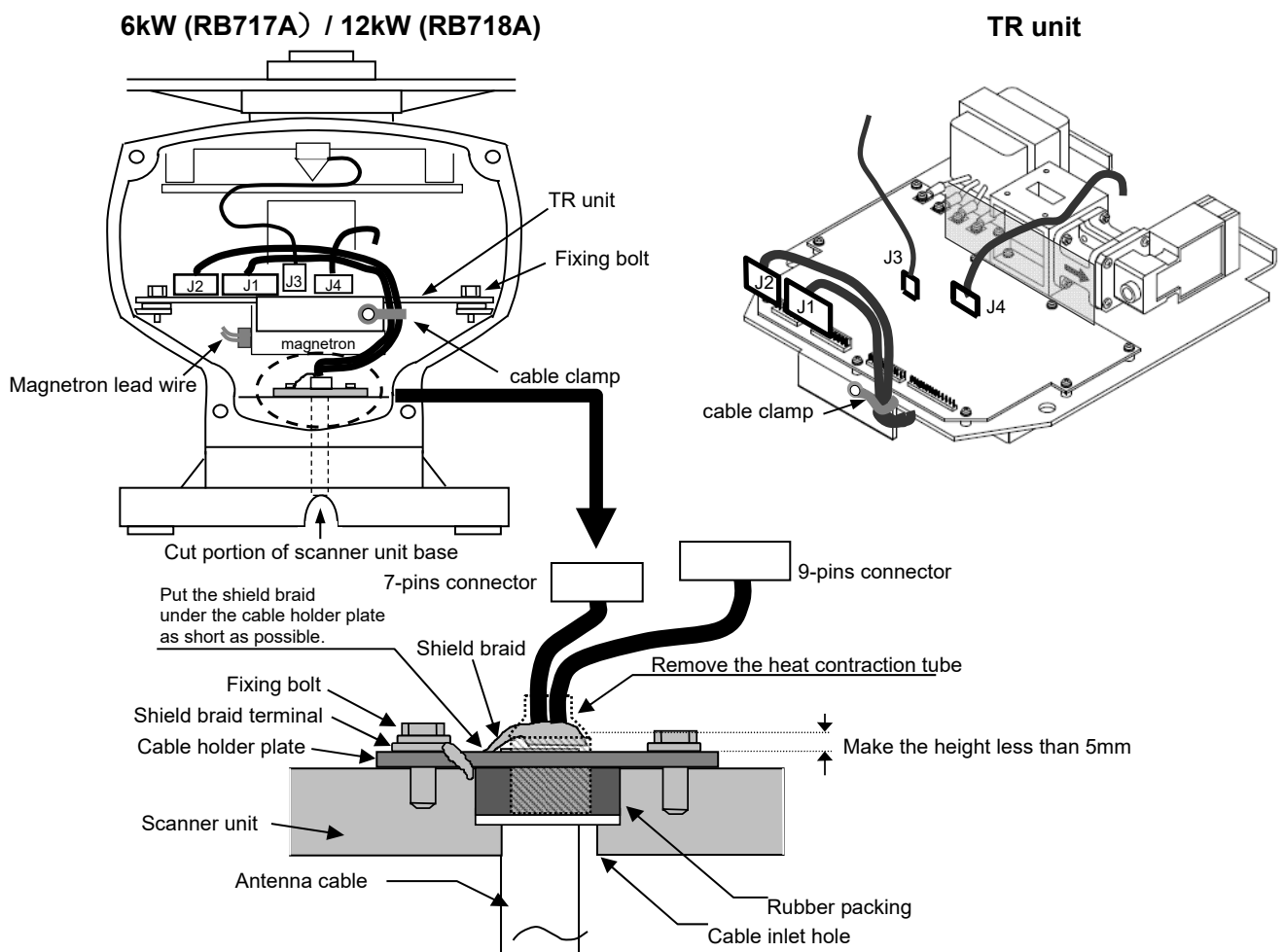

5.2 Mutual Connection Diagram

242J158055 (RB804/RB805)
 242J159098 (RB806/RB717A/RB718A)

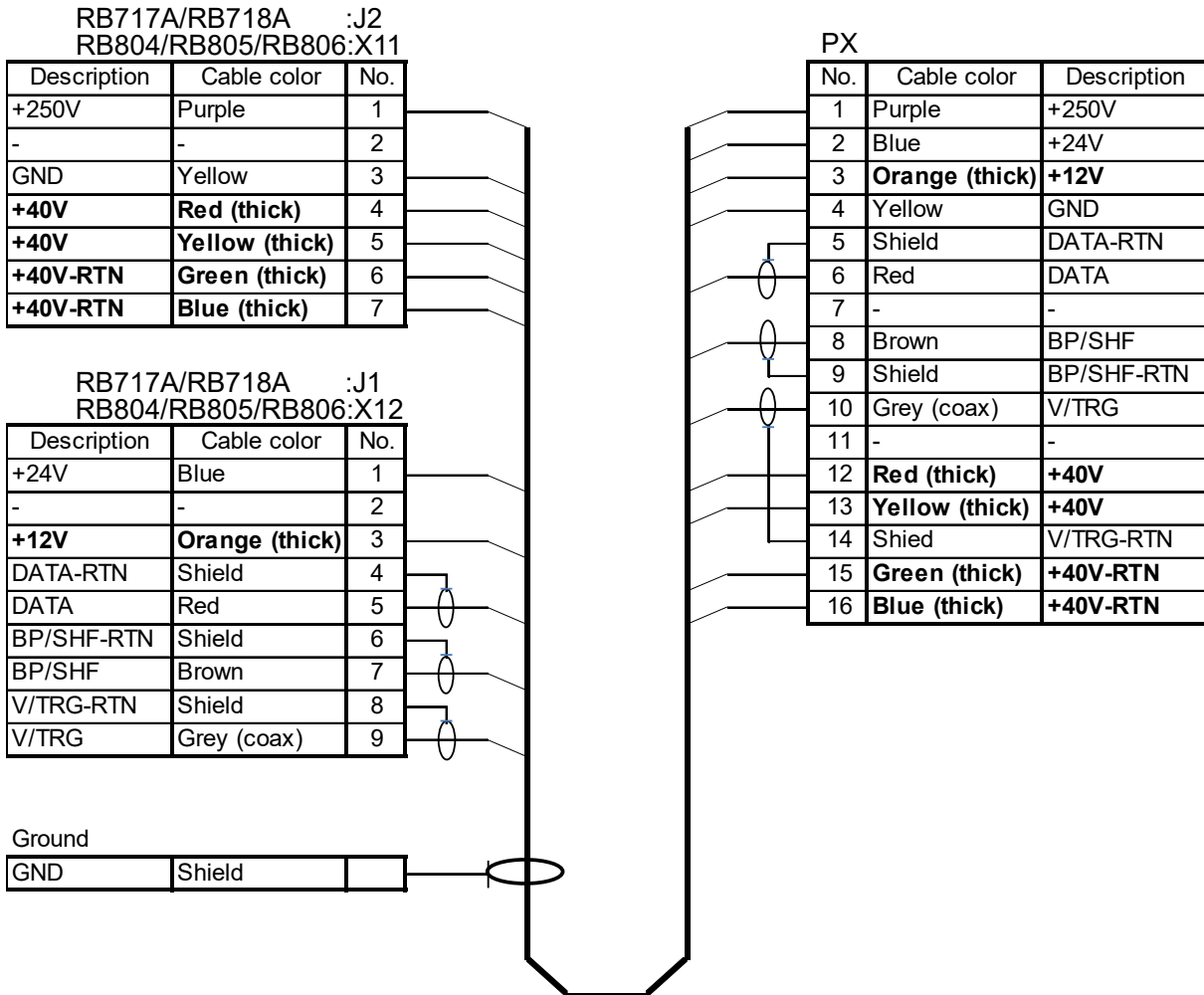

CW-845 (RB807/RB808)

Display unit

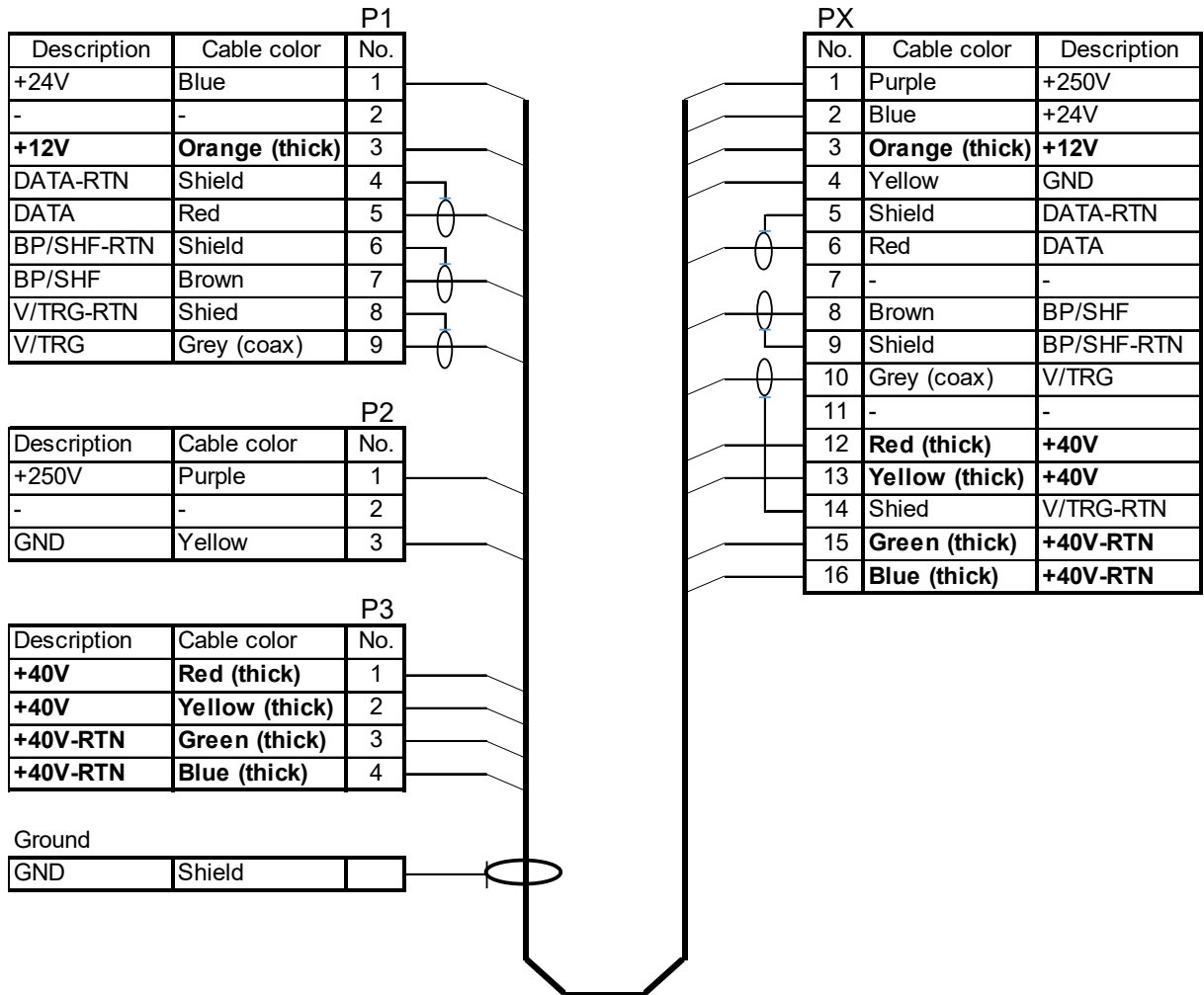

5.3 Processor Unit Installation

MDC-2000BB Processor unit can be installed either on table or panel.

Install by the following procedure.

- (1) Make 4 holes at the location to be installed.
- (2) Install the Processor unit in the installing location (square hole) and fix it with 4 tapping screws (4mm) (M4 or pan-head). (Prepare 4 mm screws suitable for thickness of installing location.)

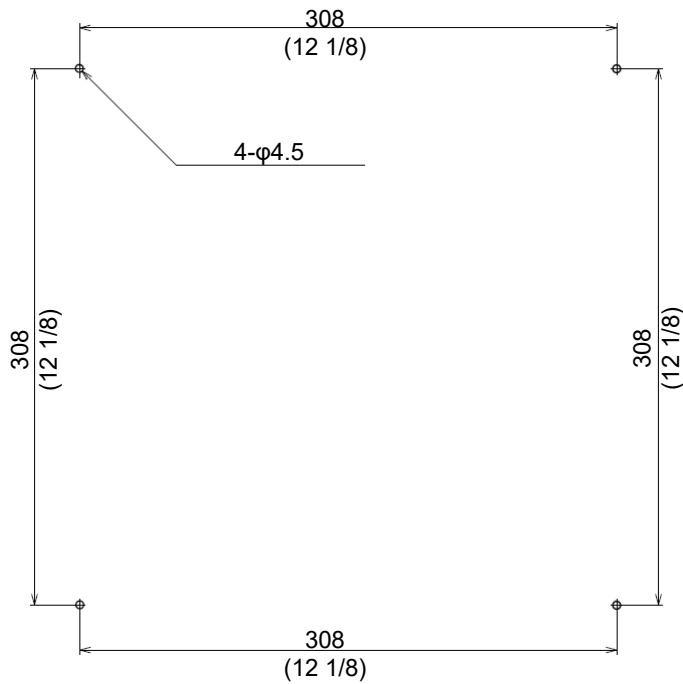

Unit : mm (inch)

Position of installation hole of Processor unit

5.4 Operation Unit Installation

MDC-2000BB Operation unit can be installed either on desk-top or flush-mounted.
Install by the following procedure.

5.4.1 Desk-top installation

- (1) Decide the location to install the Operation unit and keep the space for the maintenance works as shown in Fig. Desk-top installation of Operation unit.
- (2) Mark the position where installation plinth is installed. (3) Remove 4 plastic corner guard caps of the Operation unit (These can be easily pulled out upwards)
- (4) Fix the clamps to the Operation unit with the screw of 4M (4mm). Install the corner guard caps removed in step (3).
- (5) Confirm that the clamps matches the marking position. If not matches, correct the marking position
- (6) Install the clamps in the installing location (4 holes) and fix it with 4 tapping screws (4mm) (M4 or pan-head). (Prepare 4 mm screws suitable for thickness of installing location.)

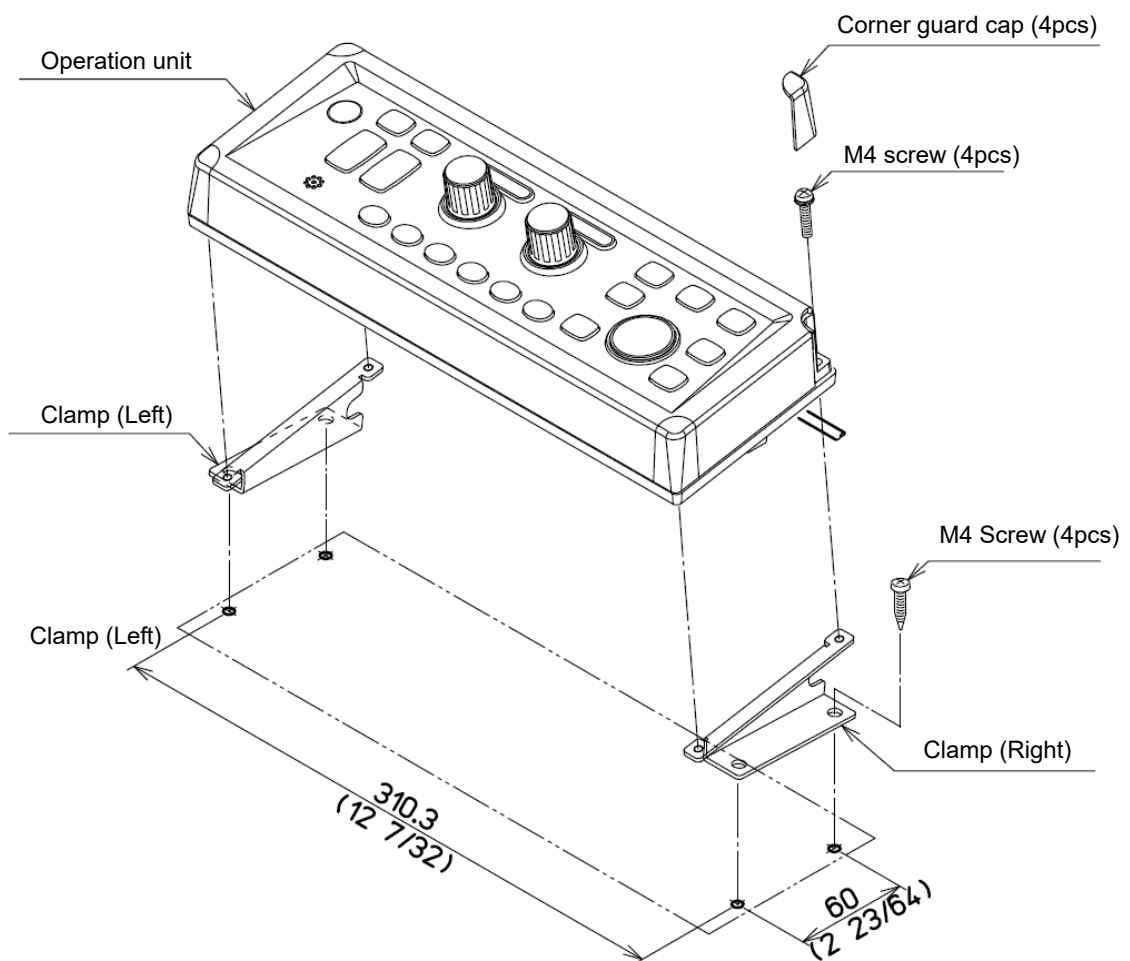

Desk-top installation of Operation unit

Unit: mm (inch)

⚠ Caution: On installing on desktop, keep the maintenance space is required as shown below.

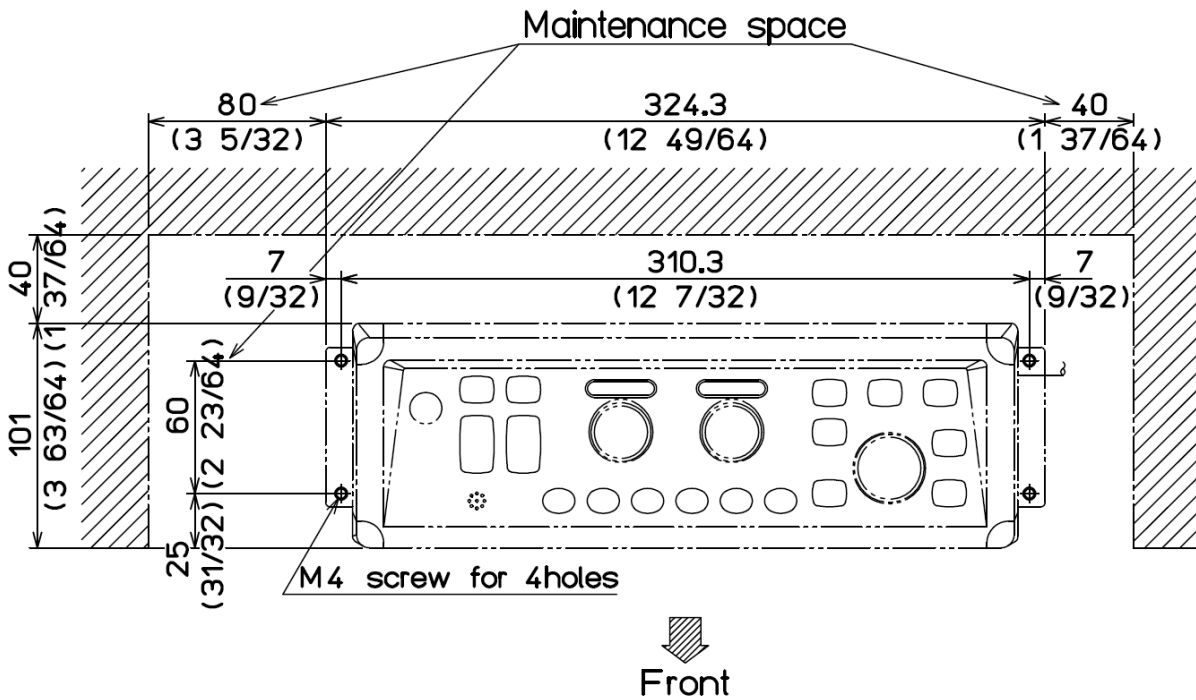

Unit: mm (inch)

Maintenance space of desk-top installation

5.4.2 Flush-mount installation

- (1) Make a square hole at the location to be installed.
- (2) Remove 4 plastic corner guard caps of the Operation unit (These can be easily pulled out upwards).
- (3) Confirm that the Operation unit matches the square hole. If not matches, correct the square hole.
- (4) Put the Operation unit and connected cable in the square hole, and set it to the position in which the Operation unit becomes parallel to the install panel.
- (5) Install the Operation unit in the installing location (square hole) and fix it with 4 tapping screws (4mm) (M4 or pan-head). (Prepare 4 mm screws suitable for thickness of installing location.)
- (6) Install the corner guard caps removed in step (2).

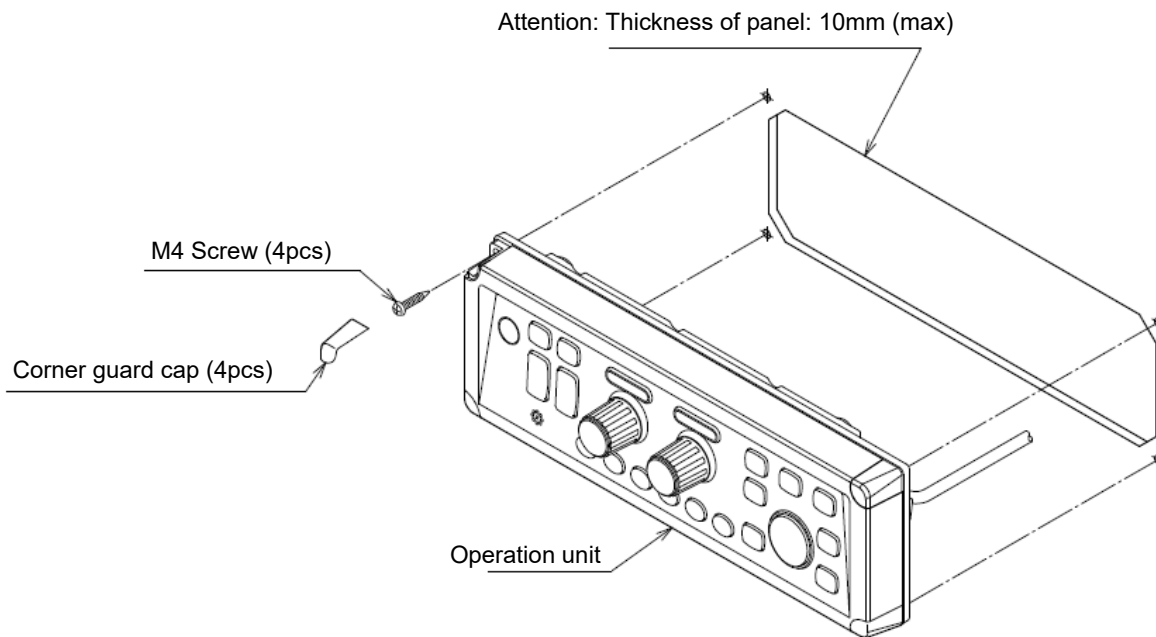

Flush-mount installation of Operation unit

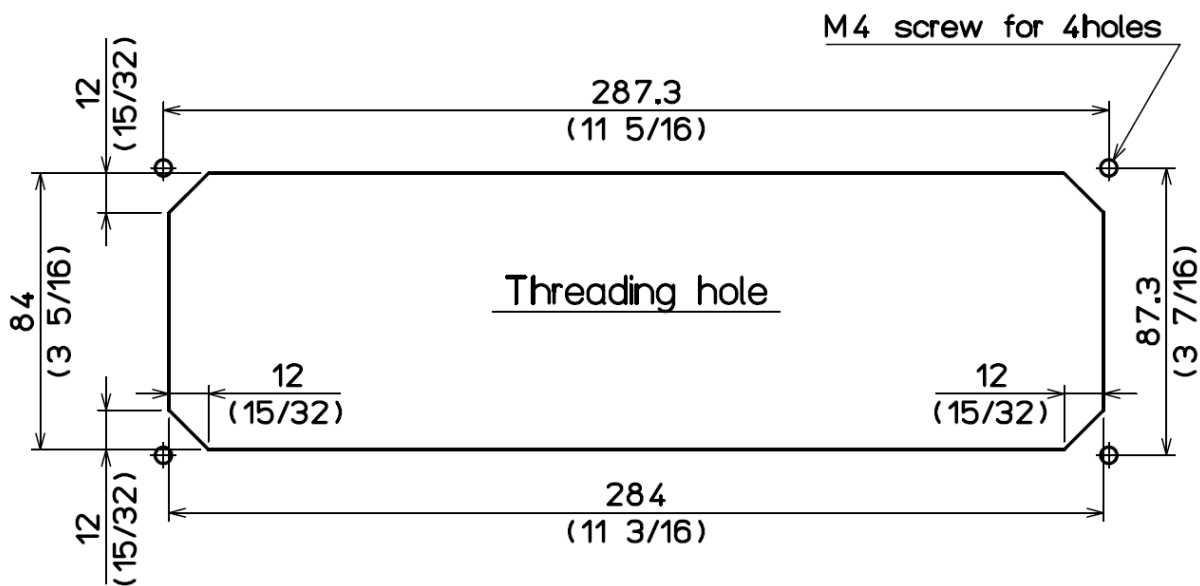

Hole for flush-mount installation of Operation unit

Unit: mm

5.5 Adjustment after Installation

Before setup, confirm the following points to operate properly the equipment

1. The ship's power, to which the radar system is connected, should be the specified voltage.
2. No person should be present around the antenna and mast. The Processor unit and Operation unit should bear the placecard, describing the caution [Radar being adjusted, do not touch the Operation unit.]

After confirming the above items, be sure to perform the adjustments.

The adjustments after the installation are the following items in 3.3 Setting of Adjustment Items.

- BRG ADJ
- TX DELAY ADJ
- MBS
- AUTO TUNE ADJ

 For the adjustments, refer to 3.3 Setting of Adjustment Items.

5.6 Wiring

Cable connection to the Processor unit

Connect the power cable, antenna cable and cables of others to specified connectors of the Processor unit. If optional navigation equipment and CCD camera are provided, connect also the cables of these equipments.

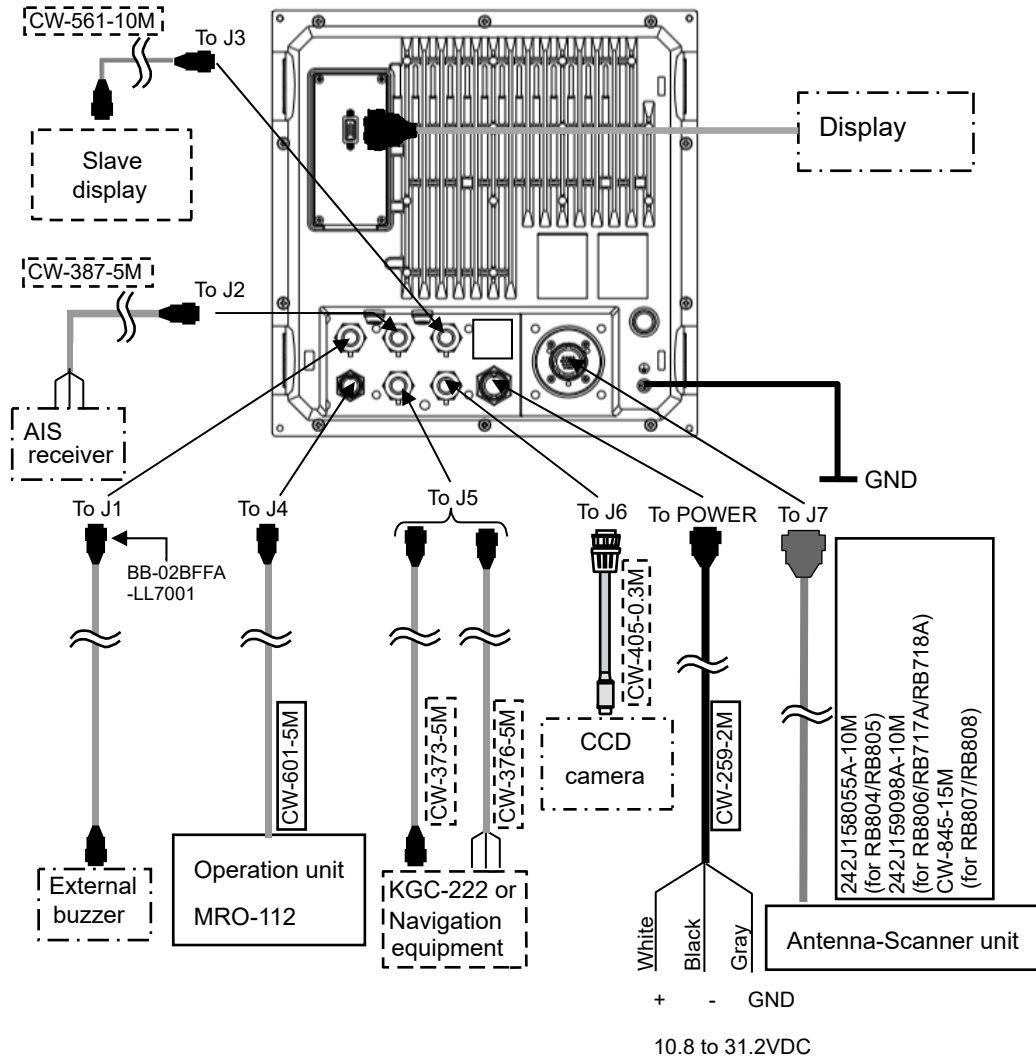

Processor unit MRM-112

Pin Assignment of Rear Connector

The pin assignment is viewed from the rear of the Display unit.

External buzzer

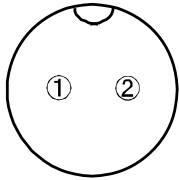

J1

- ① External buzzer+
- ② External buzzer-

AIS Input

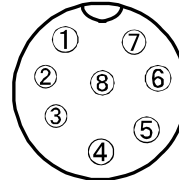

J2

- ① GND
- ② AISIN+
- ③ AISIN -
- ④ Un-connected
- ⑤ Un-connected
- ⑥ Un-connected
- ⑦ Un-connected
- ⑧ Un-connected

Note: For the rated voltage of the buzzer, use the same DC voltage of the ship's power supply to which the radar Processor unit is connected.

Slave display

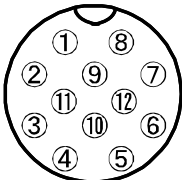

J3

- ① Video output
- ② Trigger output
- ③ GND
- ④ Azimuth output
- ⑤ Heading line output
- ⑥ GND
- ⑦ Video signal input
- ⑧ Trigger input
- ⑨ GND
- ⑩ Azimuth input
- ⑪ Heading line input
- ⑫ +12V output

Operation unit

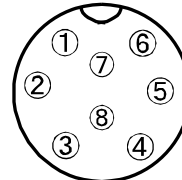

J4

- ① RX-
- ② +12V
- ③ TX-
- ④ TX+
- ⑤ GND
- ⑥ KX+
- ⑦ Power SW+
- ⑧ Power SW-

NMEA/IEC61162 Input/Output

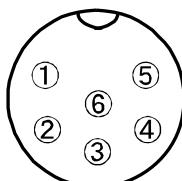

J5

- ① GND
- ② NMEA TX+
- ③ NMEA TX-
- ④ NMEA RX+
- ⑤ NMEA RX-
- ⑥ +12V output

CCD camera Input

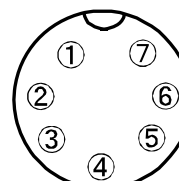

J6

- ① Camera1 input
- ② Camera1 GND
- ③ Not-used
- ④ Not-used
- ⑤ Not-used
- ⑥ Not-used
- ⑦ Not-used

+12V (Maximum 0.8A) can be supplied for GPS-20AMkII, etc.

Antenna-Scanner unit

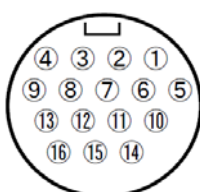

J7

- ① +250V
- ② +24V
- ③ +12V
- ④ GND
- ⑤ DAT-R
- ⑥ DAT
- ⑦ Un-connected
- ⑧ BP/SHF
- ⑨ BP/SHF-R
- ⑩ V/TRIG
- ⑪ Un-connected
- ⑫ +40V
- ⑬ +40V
- ⑭ V/TRIG-R
- ⑮ +40V-R
- ⑯ +40V-R

Power Input

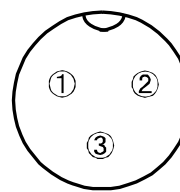

POWER

- ① POWER-
- ② POWER+
- ③ GND

Connection of DC power cable (CW-259-2M)

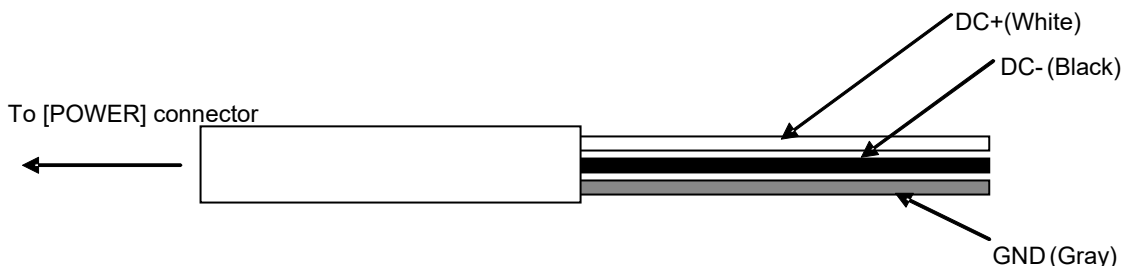

Grounding

- Use the large diameter cable for ground wire as possible.
- Connect the ground wire to the ground material at a shortest distance.
- When connecting the external equipment whose positive polarity is connected to the ground line, do not connect the ground of the signal line to the cabinet ground.

Connection with the AIS Receiver (J2) (Prepared by a user)

Use the CW-387-5M (Optional) when installing the AIS receiver. For connecting any equipment, one end of the CW-387-5M is left un-treated. Prepare a connector suitable for the equipment you desire to connect.

The connection cable (CW-387-5M) consists of 14 core wires (7 pairs) and the shield wire around them. A signal is inputted from the blue (AISIN+) and white (AISIN-) wires.

For connection of the CW-387-5M and AIS receiver, refer to the illustration below.

When cables are connected, please perform the waterproof and insulation treatment on the junction with self-bonding tape or similar materials.

Structure of CW-387-5M

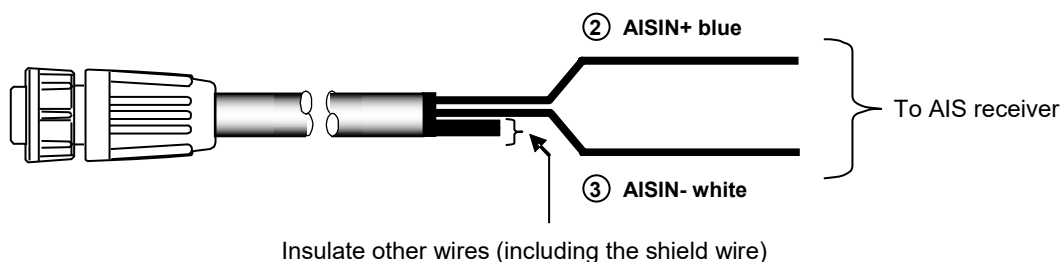

Connection with the navigation equipment (J5)

Two NMEA0183/IEC61162 input/output ports are provided. Connect the navigation equipment and the external equipment such as KODEN made GPS sensor to them. The optional cable with connectors at both ends is available. The CW-376-5M of which one end is left untreated is also available. Prepare a cable suitable for the equipment you desire to connect.

The connection cable CW-376-5M consists of six core wires and the shield wire around them. A signal is outputted from the white (NMEA TX+) and red (NMEA TX-) wires, and a signal is inputted from the orange (NMEA RX+) and black (NMEA RX-) wires.

For wiring of CW-376-5M, refer to the illustration below.

When cables are connected, please perform the waterproof and insulation treatment on the junction with self-bonding tape or similar materials.

Structure of CW-376-5M

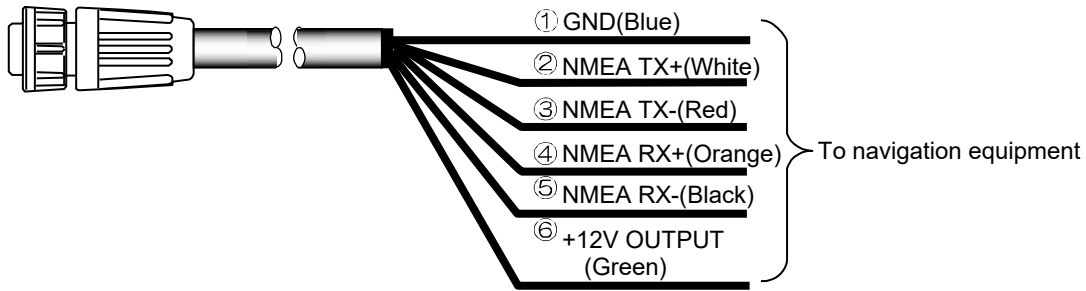

⚠ Caution: Insulate the un-used lead wires by winding them with an insulation tape not to contact each other.

Connection of CCD Camera (J6) (Prepared by a user)

The optional product CW-405-0.3M is equipped with a RCA jack for connection to the CCD camera (NTSC/PAL/SECAM), Connect the video output terminal (RCA plug (In most cases, yellow)) of your CCD camera. Perform the waterproof treatment on the junction of the RCA terminal with a self-fusion tape.

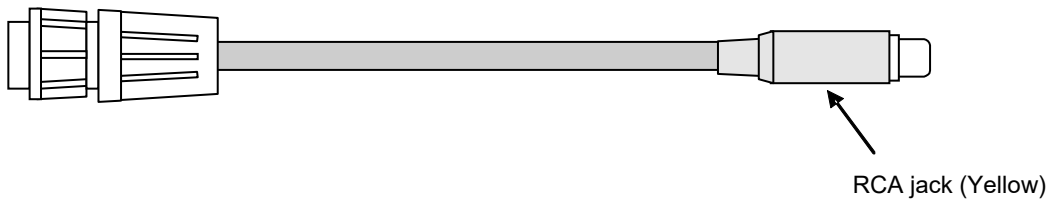

5.7 List of Input/Output Sentence

Input Sentence

The sentences shown on the table below can be received. In NMEA0183 Ver. 1.5, 2.0 and 3.0, inputting is possible.

Information	Priority of Sentence
Latitude/Longitude	GGA > RMC > RMA > GNS > GLL
Heading	THS > HDT > HDG > HDM > VHW > RMC > RMA > VTG
Ship speed	RMC > RMA > VTG > VHW
WPT	BEC > BWC > BWR > RMB
Cross Track Error	RMB > XTE
Wind direction	MWV > MWD
Wind speed	MWV > MWD
Water depth	DPT > DBT
Water temperature	MTW

Output Sentence

The TTM and TLL sentences can be transmitted.

Outputting is performed in NMEA0183 Ver. 2.0.

Sentence	Information
TTM*	Target Information
TLL**	Target Position

* To output the TTM sentence, install the ATA board (optional) and heading bearing data and ship's speed data are required.

** To output the TLL sentence, the latitude and longitude data and the bearing signal data are required.

5.8 Junction Box (JB-35) Installation

When JB-35 is connected, NMEA0183 port can be increased from one to three.

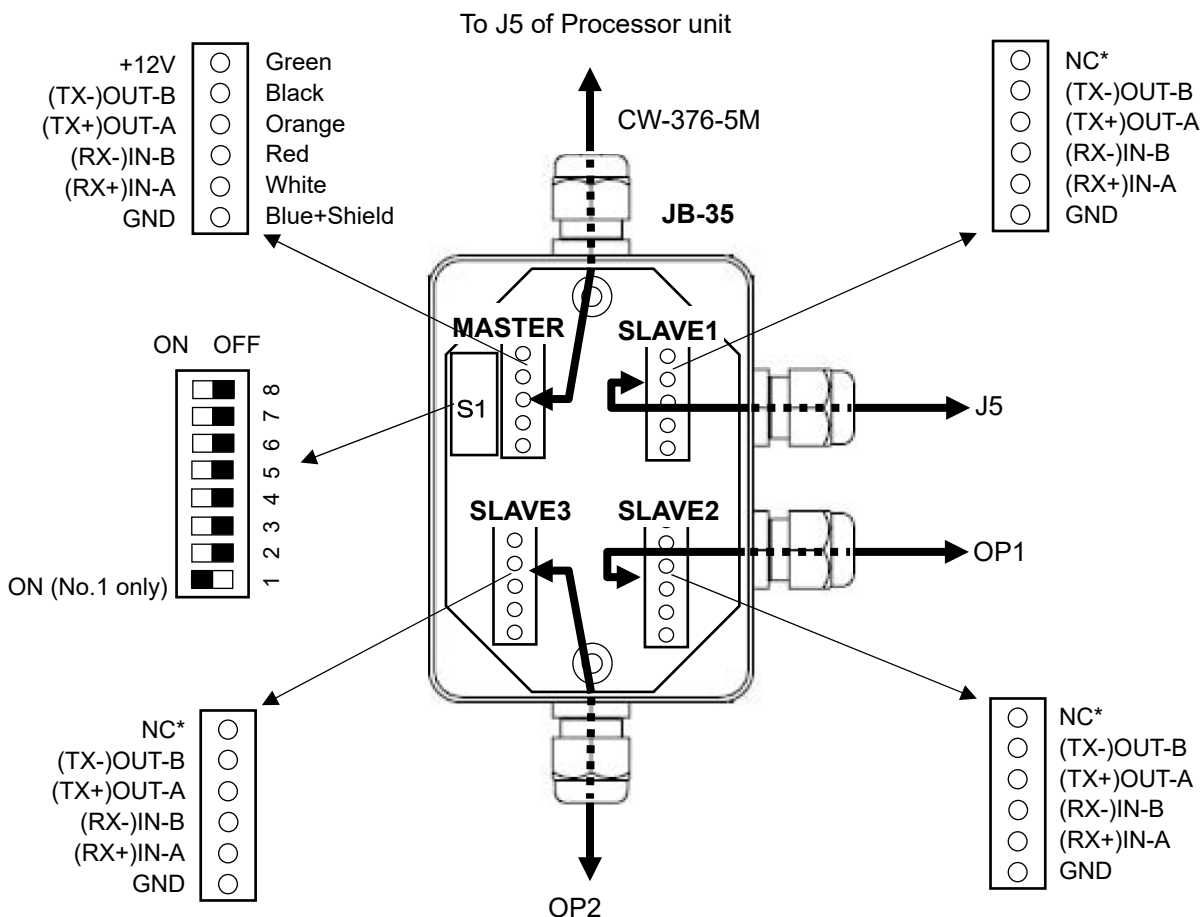

* Ensure that not to connect any cable to NC pin of SLAVE1 (J5), SLAVE 2 (OP1) and SLAVE3 (OP2).

* JB-35 should be removed when renewing the system program.

- This page intentionally left blank.-

Chapter 6 Attached Table

6.1 Menu Configuration

【MENU】 key

ECHO	<ul style="list-style-type: none"> — MODE (H UP_{RM}, N UP_{RM}, N UP_{TM}, C UP_{RM}, C UP_{TM}, WPT UP_{RM}) — DISPLAY SELECT (PPI, PPI/PPI, PPI/NAV) — PROCESS (OFF, ON) — PULSE (RESO-P PRI., GAIN PRI.)
TRAILS	<ul style="list-style-type: none"> — TRAIL MODE (REL, TRUE) — TRAIL TIME (OFF, 15SEC, 30SEC, 1MIN, 3MIN, 6MIN, 15MIN, 30MIN, CONTINUE) — TRAIL SHAPE (STANDARD, DECREMENT) — TRAIL LEVEL (1 to 7: 7)
DISPLAY	<ul style="list-style-type: none"> — COLOR (STANDARD, DAY, NIGHT, USER SET) — CURSOR SHAPE (STANDARD, LONG, EBL + VRM) — PI (OFF, ONE SIDE, BOTH SIDES) — PI NUMBER (1 to 7: 7) — BRG TRUE/REL (REL, TRUE) — VECTOR (0 to 60MIN: 1MIN) — VECTOR TRUE/REL (REL, TRUE)
ALARM	<ul style="list-style-type: none"> — ALARM MODE (OFF, IN, OUT) — DETECT LEVEL (1 to 7: 1) — DETECT COUNT (1 to 10: 1) — SLEEP (OFF, 5MIN, 10MIN, 15MIN) — LIM CPA (0.0 to 19.9NM: 0.0NM) — LIM TCPA (1.0 to 60.0MIN: 1.0MIN)
AIS	<ul style="list-style-type: none"> — AIS (OFF, ON) — LIMIT (1.0 to 20.0NM: 1.0NM) — INFO (OFF, ON) — INFO NUMBER (1 to 100: 1)
ATA	<ul style="list-style-type: none"> — AUTO DETECT AREA (OFF, ON) — ACQ — DELETE (NUMBER, CURSOR) — ALL DELETE — MAN ACQ NUM (0 to 50: 30) — INFO (OFF, ON) — INFO NUMBER (0 to 49: 0) — ATA TGT LEVEL (1 to 7: 7) — PERFORMANCE (0 to 7: 0)

A

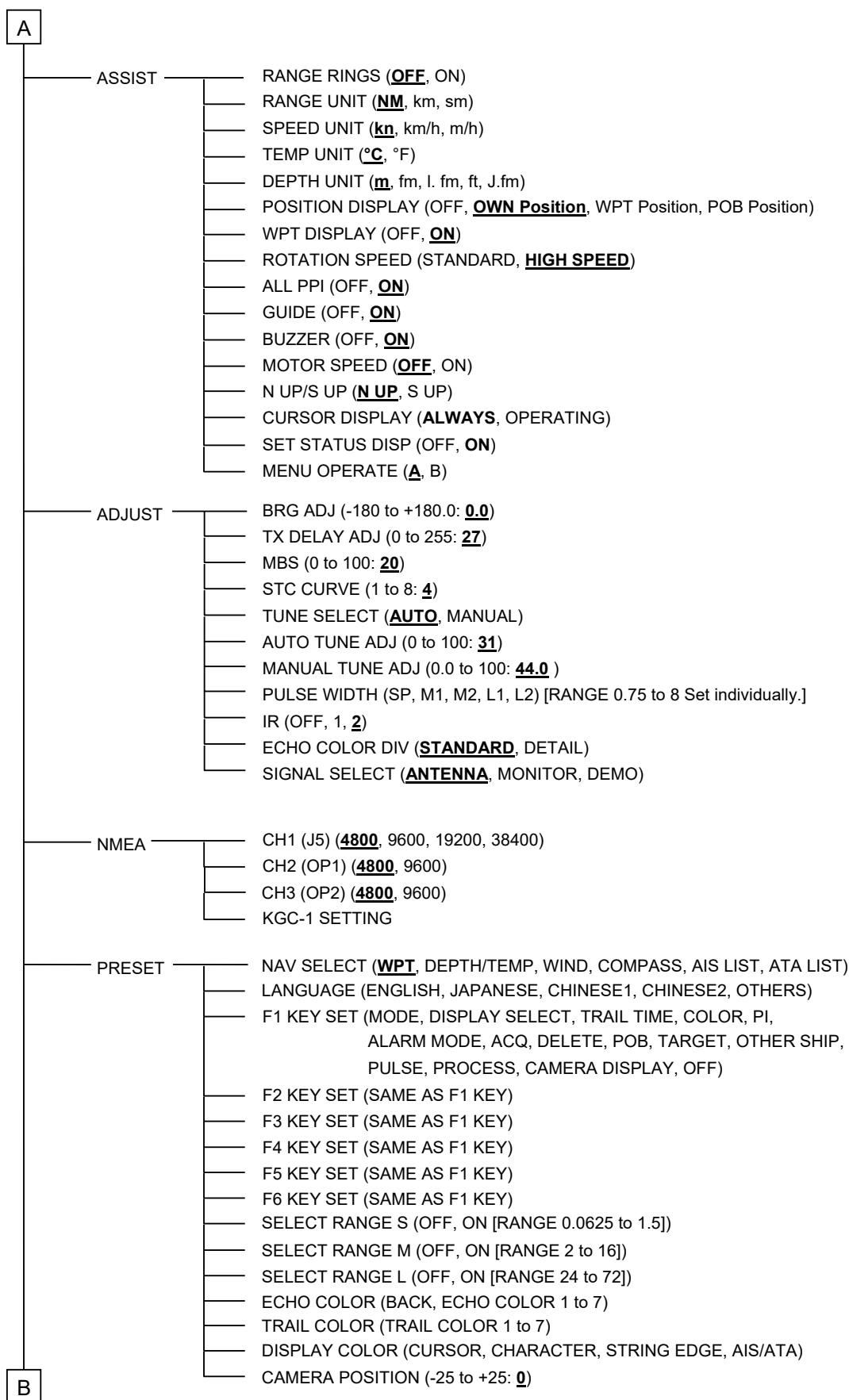

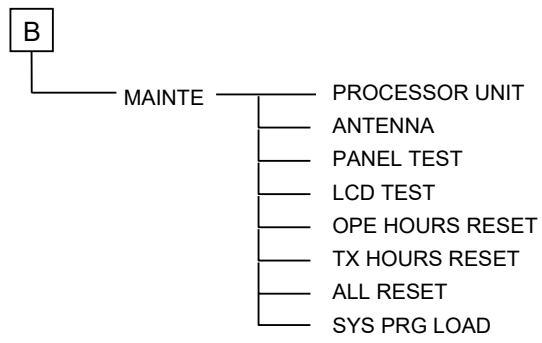

6.2 Specifications

Antenna-Scanner unit

Specification item	Content			
Model	MDC-2003BB	MDC-2005BB		MDC-2004BB
Type	RB804	RB805		RB806
Antenna type	Radome			Open antenna
Antenna length	1.2 feet	2 feet		3 feet 4 feet
Output power (Peak)	4 kW			
Output frequency	9410 MHz ± 30 MHz			
Horizontal beam width	5.9°	3.9°		2.5° 1.8°
Vertical beam width	25°			22°
Rotation	24 rpm or 48 rpm			
IF center frequency	60 MHz			
Range accuracy	8 meters or 1% of the range scale selected, whichever is the greater			
Bearing accuracy	1° or less			
Minimum detecting distance	Within 25 m			
Range resolution	Within 25 m			
Warm-up time	2 min			
Pulse width	0.08 μs, 0.15 μs, 0.3 μs, 0.5 μs, 1 μs			

Environmental

Operating temperature	-25°C to +55°C
Store temperature	-30°C to +70°C
Upper limit of humidity	93% ± 3% (at +40°C)
Water protection	IPX6

Processor unit (MRM-112) and Operation unit (MRO-112)

Model	MDC-2003BB	MDC-2005BB		MDC-2004BB														
Processor Unit	MRM-112																	
Operation Unit	MRO-112																	
Display resolution	640 x 480 pixels (VGA)																	
Off-centering	Max. 66%																	
Echo area	2 types (Full screen, Inside of effective diameter)																	
Basic range	0.0625 to 32 NM			0.0625 to 48 NM														
Range scales	0.0625	0.125	0.25	0.5	0.75	1	1.5	2	3	4	6	8	12	16	24	32	48	
Range interval	0.0312	0.0625	0.125	0.25	0.5	1	2	3	4	6	8	12						
Presentation modes	Head-up, North-up*, Course-up*, WPT-up**																	
Indication system	PPI, PPI/PPI, PPI/NAV																	
Video levels	8 levels (Colors)																	
Range unit	NM, km, sm																	
Alarms	Echo (IN / OUT), ATA / AIS (CPA / TCPA) etc.																	
Functions	Interference rejection, Target expansion, VRM, EBL, Parallel index, Cursor position (Lat/Lon), Bearing (true/relative), Trail***, Slave display monitor input/output, External Buzzer, Accepts CCD camera input, Dual display																	
Input data format and sentences	NMEA0183 Ver.1.5/2.0/3.0 BEC.BWC.BWR.DPT.DBT.GGA.GLL.GNS.HDG.HDM.HDT.MTW.MWD.MWV.RMA.RMB.RMC.THS.VHW.VTG.XTE																	
Output data format and sentences	NMEA0183 Ver.2.0 TTM, TLL																	
NMEA input/output port(s)	1																	
AIS interface***	100 targets (Option)																	
ATA***	50 targets (Option)																	
Power supply	10.8 to 31.2 VDC																	
Power consumption (at 24VDC)	65 W or less												80 W or less					

Environmental

Operating temperature	-15°C to +55°C
Store temperature	-30°C to +70°C
Upper limit of humidity	93% ± 3% (at +40°C)
Water protection	Processor Unit (MRM-112) : IPX0 Operation Unit (MRO-112) : IPX5
Vibration resistant	IEC60945-4th

* Requires heading data input.

** Requires waypoint data input.

*** Requires bearing data, ship's speed data and latitude / longitude data input.

Antenna-Scanner unit

Specification item	Content							
Model	MDC-2006BB		MDC-2012BB		MDC-2060BB		MDC-2010BB	
Type	RB807		RB808		RB717A		RB718A	
Antenna type	Open antenna							
Antenna length	4 feet	6 feet	4 feet	6 feet	4 feet	6 feet	4 feet	6 feet
Output power (Peak)	6 kW		12 kW		6 kW		12 kW	
Output frequency	9410 MHz ± 30 MHz							
Horizontal beam width	1.8°	1.2°	1.8°	1.2°	1.8°	1.2°	1.8°	1.2°
Vertical beam width	22°							
Rotation	24 rpm or 48 rpm		24 rpm or 42 rpm		24 rpm or 48 rpm			
IF center frequency	60 MHz							
Range accuracy	8 meters or 1% of the range scale selected, whichever is the greater							
Bearing accuracy	1° or less							
Minimum detecting distance	Within 25 m							
Range resolution	Within 25 m							
Warm-up time	2 min							
Pulse width	0.08 μs, 0.15 μs, 0.3 μs, 0.5 μs, 1 μs							

Environmental

Operating temperature	-25°C to +55°C
Store temperature	-30°C to +70°C
Upper limit of humidity	93% ± 3% (at +40°C)
Water protection	IPX6

Processor unit (MRM-112) and Operation unit (MRO-112)

Model	MDC-2006BB	MDC-2012BB	MDC-2060BB	MDC-2010BB
Processor Unit	MRM-112			
Operation Unit	MRO-112			
Display resolution	640 x 480 pixels (VGA)			
Off-centering	Max. 66%			
Echo area	2 types (Full screen, Inside of effective diameter)			
Basic range	0.0625 to 64 NM	0.0625 to 72 NM	0.0625 to 64 NM	0.0625 to 72 NM
Range scales	0.0625 : 0.125 : 0.25 : 0.5 : 0.75 : 1	1.5 : 2 : 3 : 4 : 6 : 8	12 : 16 : 24	32 : 48 : 64 : 72
Range interval	0.0312 : 0.0625 : 0.125 : 0.25	0.5 : 1	2 : 3 : 4 : 6 : 8	12 : 16 : 18
Presentation modes	Head-up, North-up*, Course-up*, WPT-up**			
Indication system	PPI, PPI/PPI, PPI/NAV			
Video levels	8 levels (Colors)			
Range unit	NM, km, sm			
Alarms	Echo (IN / OUT), ATA / AIS (CPA / TCPA) etc.			
Functions	Interference rejection, Target expansion, VRM, EBL, Parallel index, Cursor position (Lat/Lon), Bearing (true/relative), Trail***, Slave display monitor input/output, External Buzzer, Accepts CCD camera input, Dual display			
Input data format and sentences	NMEA0183 Ver.1.5/2.0/3.0 BEC.BWC.BWR.DPT.DBT.GGA.GLL.GNS.HDG.HDM.HDT.MTW.MWD.MVW.RMA.RMB.RMC.THS.VHW.VTG.XTE			
Output data format and sentences	NMEA0183 Ver.2.0 TTM, TLL			
NMEA input/output port(s)	1			
AIS interface***	100 targets (Option)			
ATA***	50 targets (Option)			
Power supply	10.8 to 31.2 VDC			
Power consumption (at 24VDC)	110 W or less	130 W or less	110 W or less	130 W or less

Environmental

Operating temperature	-15°C to +55°C
Store temperature	-30°C to +70°C
Upper limit of humidity	93% ± 3% (at +40°C)
Water protection	Processor Unit (MRM-112) : IPX0 Operation Unit (MRO-112) : IPX5
Vibration resistant	IEC60945-4th

* Requires heading data input.

** Requires waypoint data input.

*** Requires bearing data, ship's speed data and latitude / longitude data input.

6.3 External View

MRM-112

Unit: mm (inch)

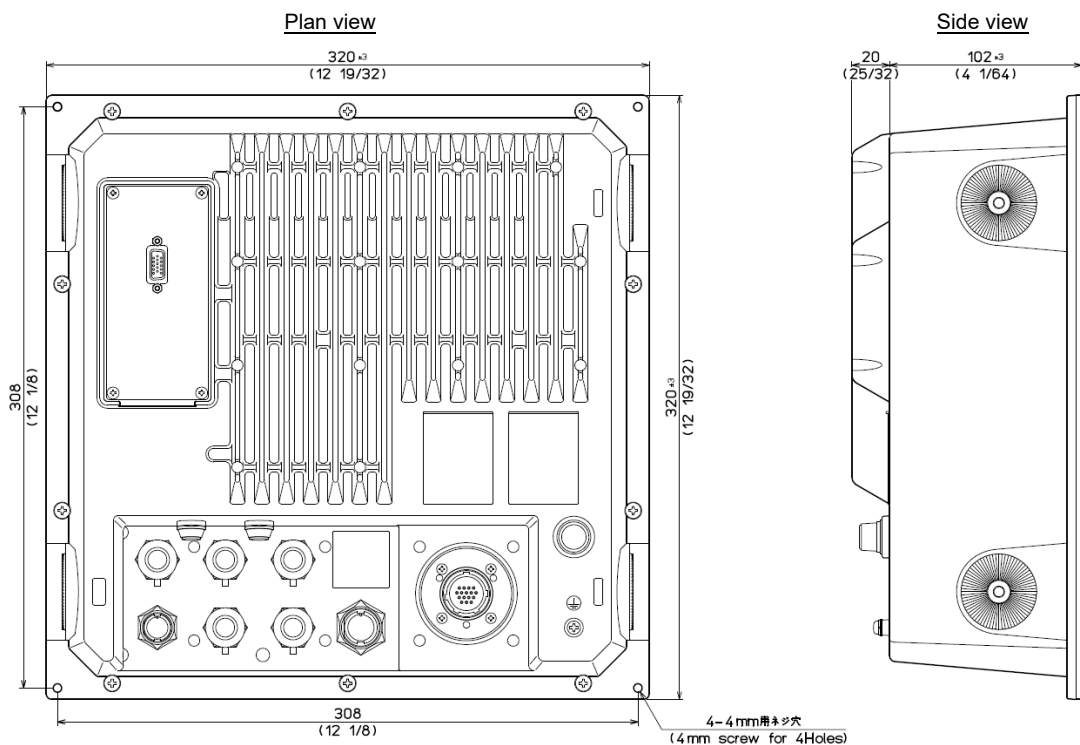

Weight: 5.1kg (11.2lb)

MRO-112

Unit: mm (inch)

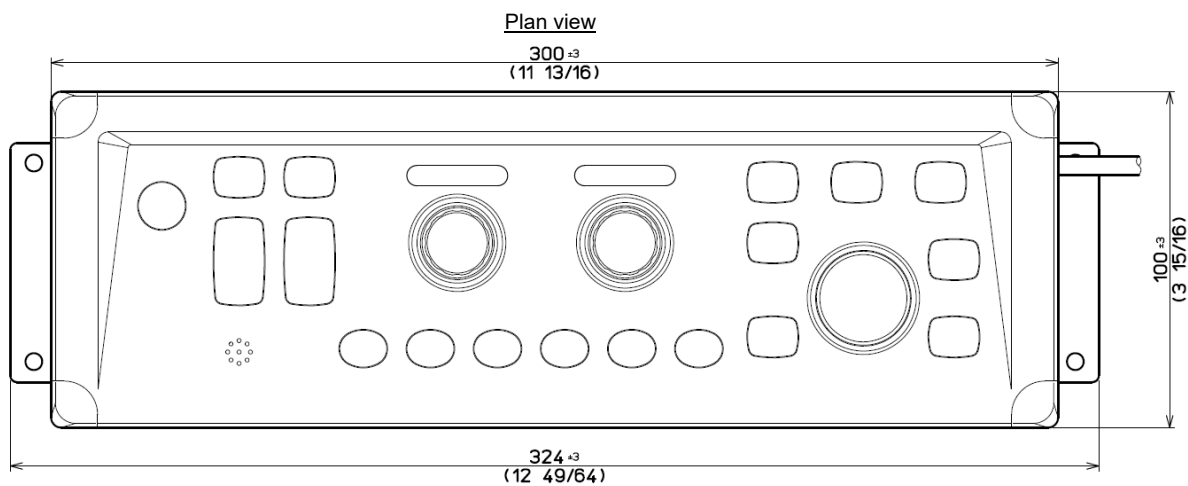

Weight: 0.94kg (2.1lb)

RB804

Unit: mm (inch)

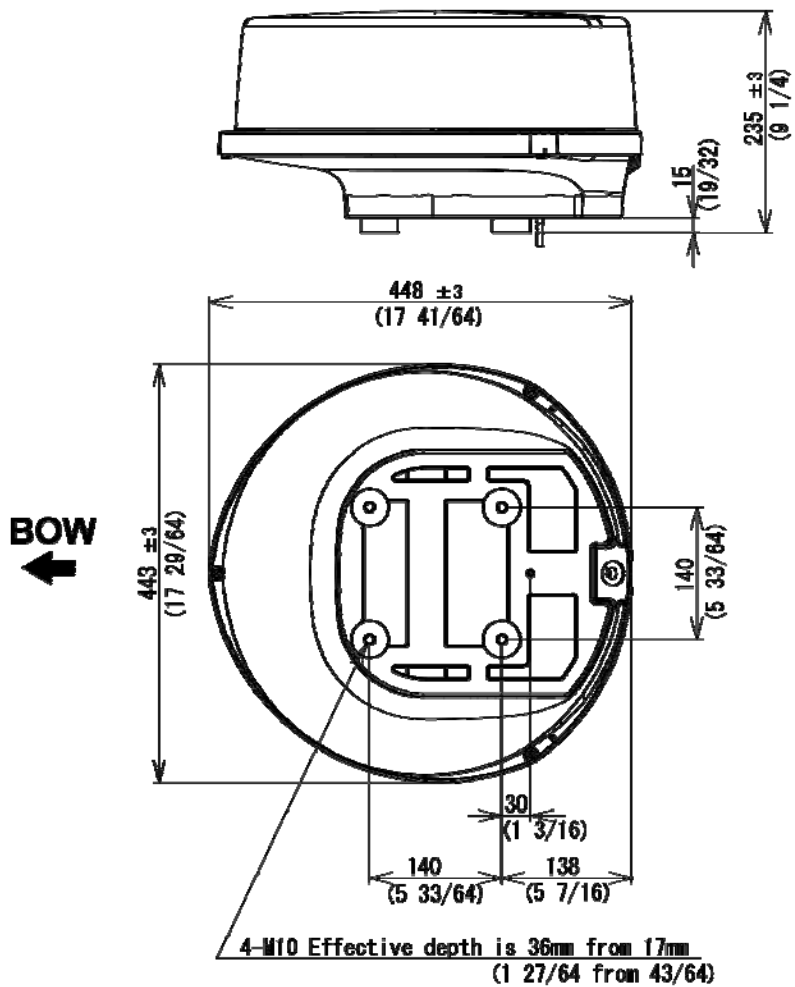

Weight: 8.3kg (18.3lb)

RB805

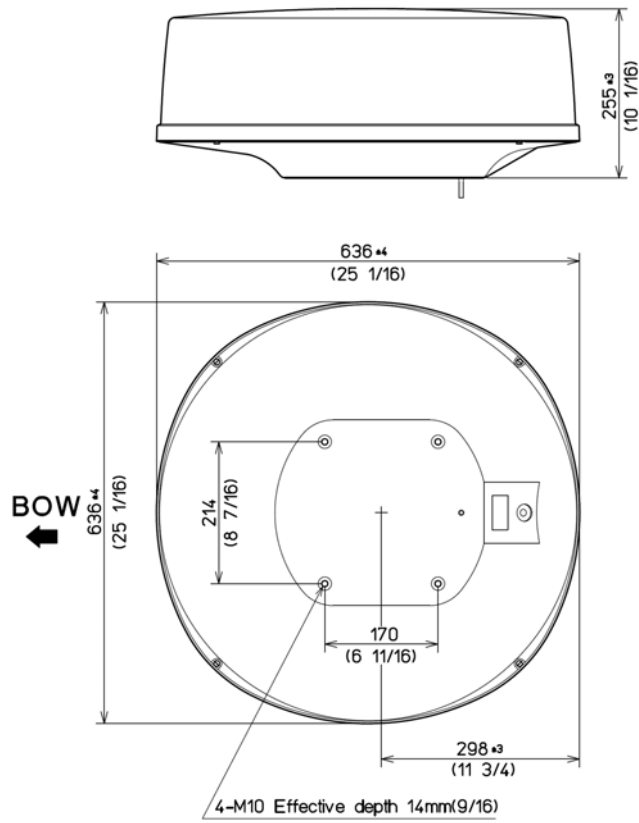

Unit: mm (inch)

Weight: 10kg

RB806 with RW701A-03/04

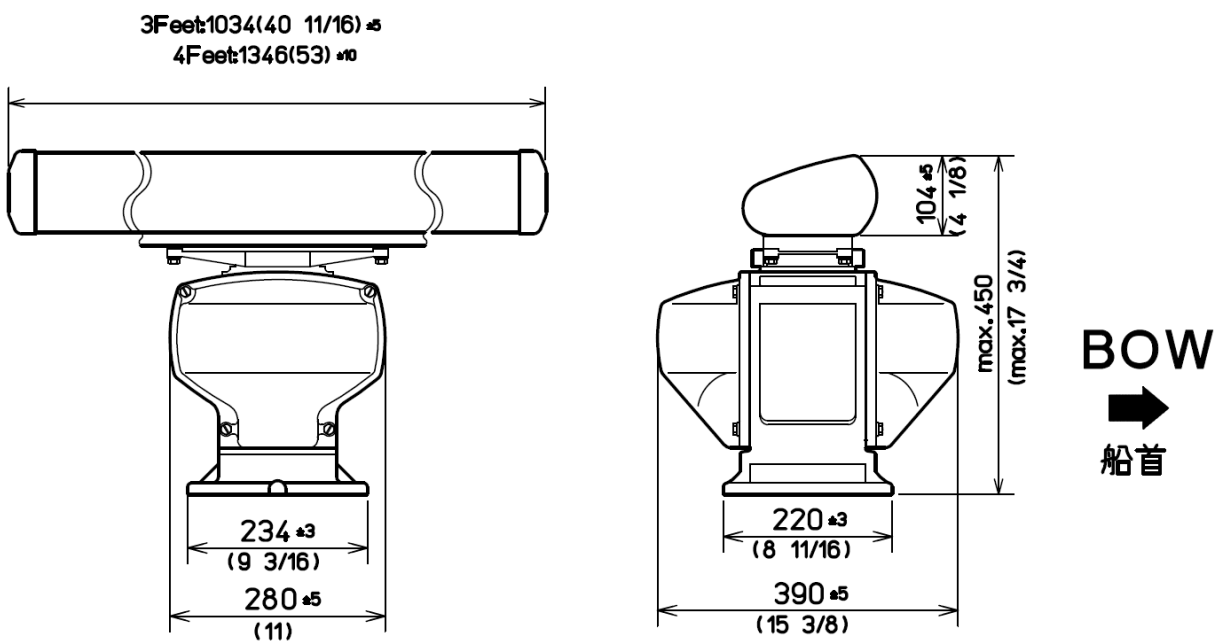

Unit: mm (inch)

Weight: 21.5kg/(47lb) . . . 3Feet(RW701A-03)
 22.5kg/(50lb) . . . 4Feet(RW701A-04)

RB807/RB808/RB717A and RB718A with RW701A-04/06

Unit: mm (inch)

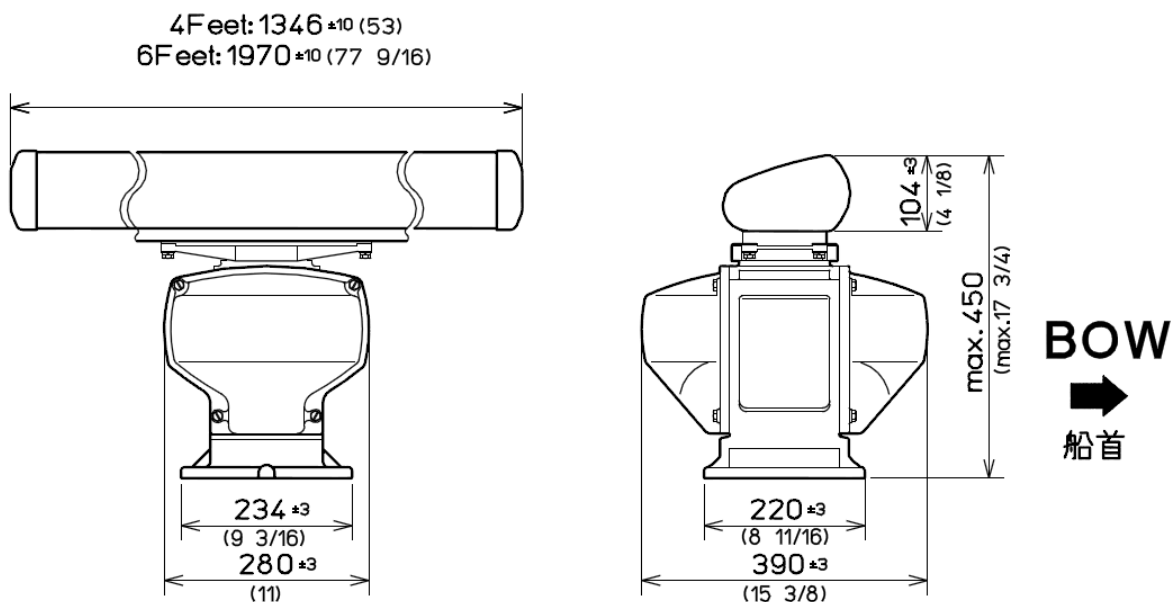

Weight: RB807/RB808: 24kg / (53lb) ... 4Feet (RW701A-04)
 26kg / (57.5lb) ... 6Feet (RW701A-06)

RB717A/RB718A: 22.5kg / (49.6lb) ... 4Feet (RW701A-04)
 24.5kg / (54lb) ... 6Feet (RW701A-06)

- This page intentionally left blank.-

Chapter 7 Principle of radar system

7.1 What is the radar system?

The radar system is a navigation device that transmits a very high frequency radio wave referred as microwave from antenna. The radar then receives the radio wave reflected by target(s) (e.g. other ship, buoy, island, etc) via the same antenna and converts the received radio wave to electronic signals and sends these signals to the Display unit. The radar makes it possible to find objects (targets), such as other ships, rocks or coastline, not seen by eyesight or in fog and allows ships to avoid these potential hazards.

As the antenna transmits while rotating, it is possible to see the current surrounding situation around your ship at a glance.

The microwave radiated from the radar is referred as pulse wave and transmitting and receiving of these waves alternate. Up to thousands of pulse waves are transmitted and received during one 360 degree rotation.

The typical radar antenna is a parabolic type or slotted array and its performance is essential for good radar performance. Some of factors affecting the quality of the target returns are the antenna beam width and the side lobe level. The narrow beam width provides a high resolution for angular orientation to distinguish objects and the low side lobe level reduces a false image effect.

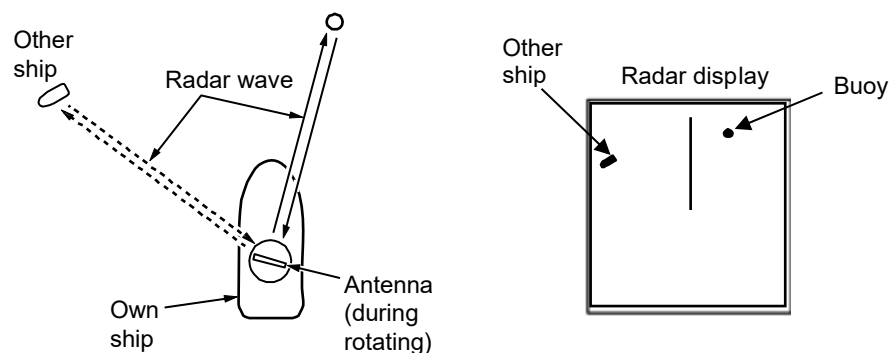

Figure 7-1 What is Radar?

Side lobe

The main lobe means the strongest radiated beam sent from the specific antenna, and the other weaker beams, are referred as side lobes. A side lobe level is a difference between the largest side lobe level and main lobe level.

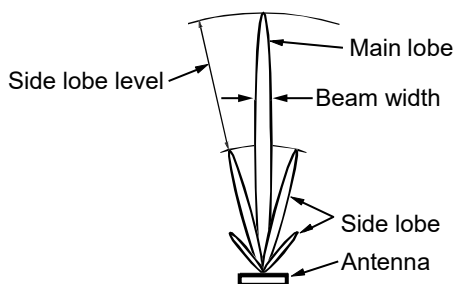

Figure 7-2 Antenna pattern

Beam width

The antenna beam width is defined as the angle where the radiation power density is within a half of the maximum power supply in the main lobe (also, referred as "half value width").

7.2 Characteristics of radar radio wave

The radio wave propagates slightly along the ground (primarily line of sight). This characteristic varies depending on the density of atmosphere but generally calculated according to the formula as shown below, considering that the distance with radar sight D is about 6% longer than the distance with optical sight.

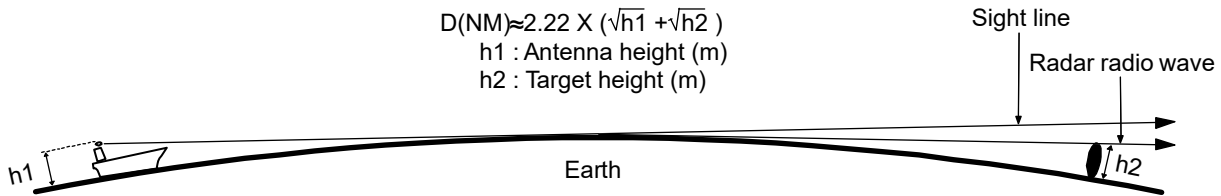

Figure 7-3 Characteristics of radar radio wave

Target with less reflection

The strength of the reflected waves from a target varies depending on not only the distance from the target, its height or size, but also (radar absorbing) material and shapes. A target with a low degree of reflection or low incident angle, such as FRP and wooden is not reflected well. Therefore, care should be taken that a FRP ship, a wooden ship or an object such as sand, a sandbar and muddy cay poor radar targets.

Since the distance from the coastline, etc. to your ship on a radar image to be seen as longer than that from the actual coastline, more caution should be used navigating around such objects.

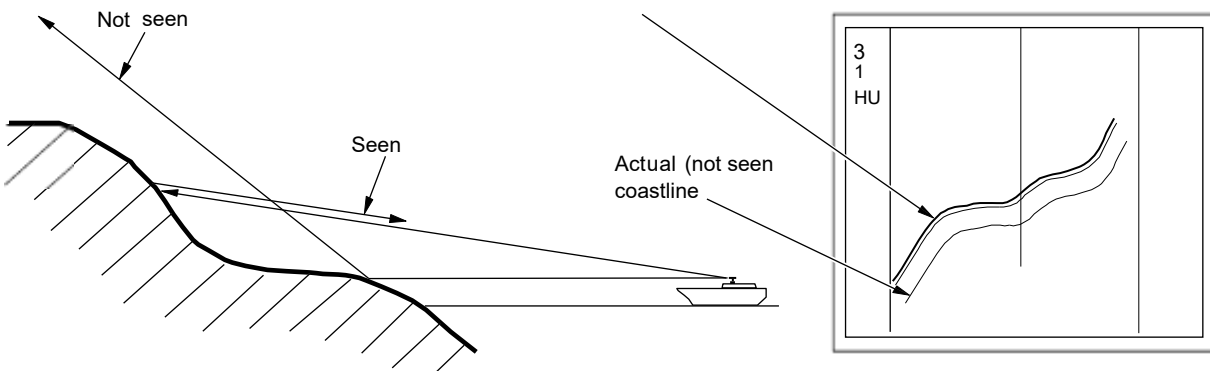

Figure 7-4 Example of targets hard to be reflected

Radar shadow

Since the radar radio wave propagates straightly, your ship's chimney stack and mast close to the antenna, a large ship or mountain can create blind spots for which the radar wave cannot penetrate. In such cases, they may completely or partially hide targets and cast a long shadow.

Since the shadow your ship's chimney stack or mast is known at the time of installation, proper selection of the antenna location is required to reduce the shadow effect. Since targets less likely to be in this shadow area than in open sea, an extra attention should be taken in shadow areas.

False image

An image that does not actually exist (false image) at sea may appear on the display.

The phenomenon that causes false echoes are categorized and be described as follows:

• **Virtual image**

The image of a large physical object in a close proximity may appear in two different orientations. One is a real image and the other is a false image caused by wave reflected on the chimney stack or the mast, etc.

On the display, one image appears with a right distance and bearing, and another one appears in the direction of chimney stack, mast, etc. These images may also be generated by being reflected multiple times from the bridges and quays too.

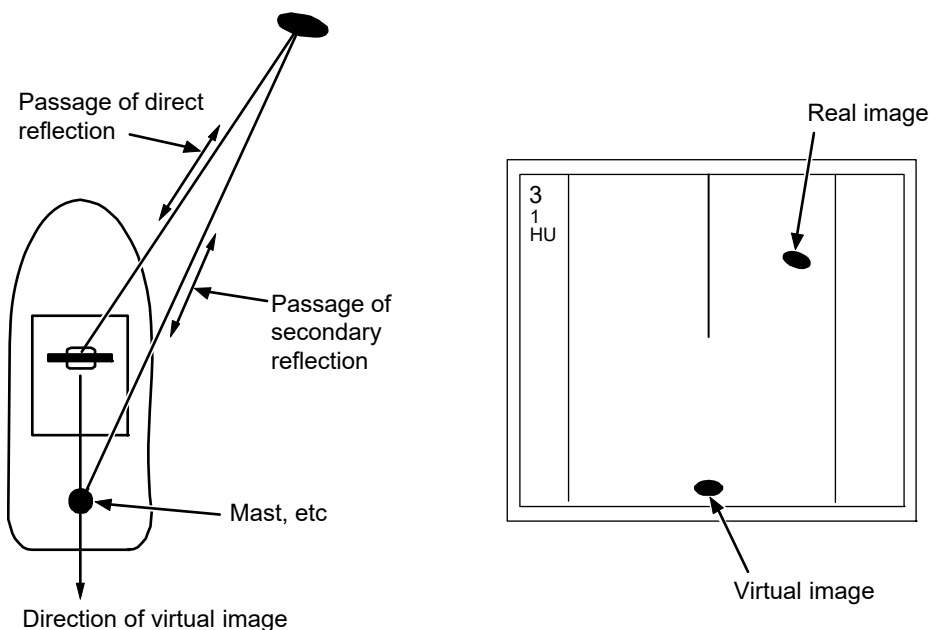
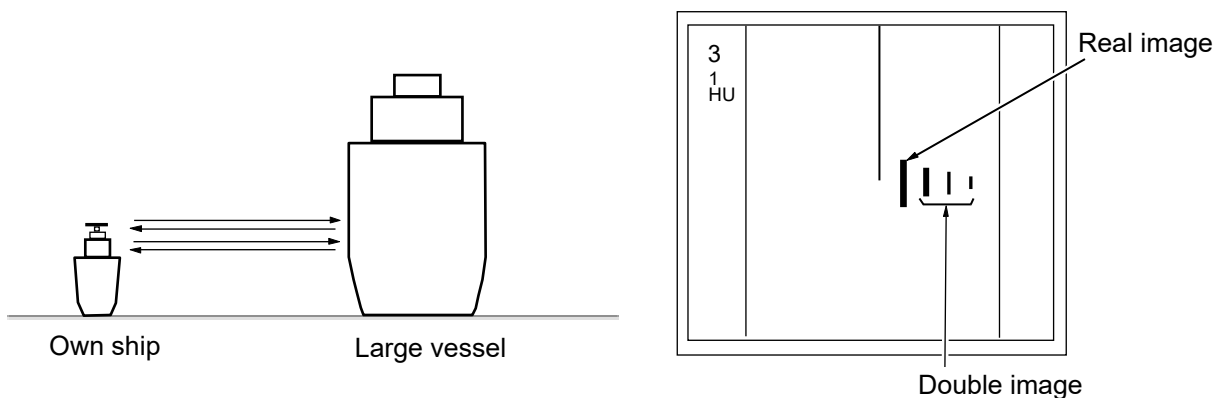

Figure 7-5 False image by virtual image

• **Duplicate target images**

When there is a big reflective surface nearby and perpendicular at a close distance (i.e. when your ship is passed by a big ship, etc.) radio wave bounces repeatedly between your ship and the other ship. Therefore, 2 to 4 images may appear at equal range in the direction of this target. The false image generated by this multi-path reflection is referred as “double targets”. In this case, the closest target is the real one.

Even if the double targets appear, if the distance and bearing between own ship and the reflective target changes, the duplicate targets will disappear. Therefore, this false image can be easily distinguished.



• **False image by sidelobe**

The microwave beam radiated from the antenna has a side lobe in different direction than that of the main beam. Since this side lobe is lower than that of main beam, the effect is negligible for targets at a long range, but a close, strong reflecting target may cause false image in a circular arc shape.

	<p>Caution If a large target such as land exists near your ship, a circular arc shaped image may appear.</p>
---	---

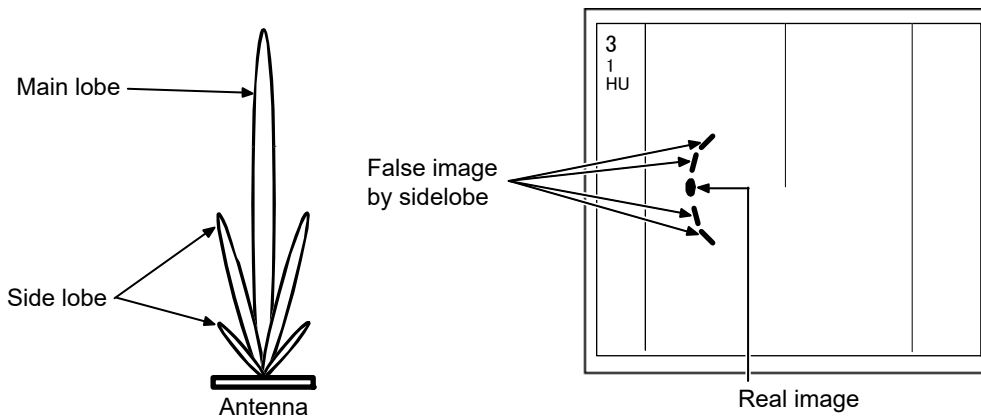

Figure 7-7 False image by sidelobe

• **False image of a distant target caused by “duct”**

Depending on a weather conditions, a duct occurs by the temperature inversion, etc. In this case, the unusual propagation of the radio wave may reach distant targets out of radar range. A target at more than the maximum range may appear as an image, and may be displayed as a false image closer than an actual distance. This phenomenon is a result of the long range echo delay time exceeds the transmission period, and is displayed as the echo in the next cycle. When changing the range of a distance, if the distance of the target changes, it can be judged as a false image.

7.3 Radar interference

When the radar with the same frequency band is used nearby, interference noise appears on a display. Although appearance of interference is not constant, the shape is almost always swirling or radial. This device features an interference rejection facility to reduce interference.



Koden Electronics Co., Ltd.

Tamagawa Office:

2-13-24 Tamagawa, Ota-ku, Tokyo, 146-0095 Japan

Tel: +81-3-3756-6501 Fax: +81-3-3756-6509

Uenohara Office:

5278 Uenohara, Uenohara-shi, Yamanashi, 409-0112 Japan

Tel: +81-554-20-5860 Fax: +81-554-20-5875

www.koden-electronics.co.jp